



PIPE TOOLS & VISES  
SINCE 1896

[www.reedmfgco.com](http://www.reedmfgco.com)



CUTTERS & CUTTER WHEELS / PLASTIC PIPE TOOLS / WATER SERVICES TOOLS / THREADERS & DIES  
TEST PUMPS & GROOVERS / VISES / WRENCHES & SOCKETS / GENERAL PIPE WORKING TOOLS



# REED COMPANY CULTURE

The company culture at Reed Manufacturing is built on shared core values – Decent Human Beings with Energy, Determination, Solutions Focus and Service Orientation. Decent Human Beings (DHB) bring integrity, dedication and a positive attitude to REED and the community. Energy and Determination shine through people invested and interested in their work and a high-quality outcome. Solutions focused persons propel REED forward in resolving issues and removing obstacles. Service oriented associates put others ahead of themselves for the collective good.

REED uses these principles to guide all decision-making and action within our organization. We review, reward and recognize REED Associates based on these core values.

## OUR PURPOSE

Creating solutions that deliver the essentials of civilization

## OUR NICHE

Pipe tool solutions for the professional trades

## CORE VALUES



### DECENT HUMAN BEING

Top of the list for REED are DHB people. Decent Human Beings are honest, ethical, kind, approachable and humbly confident. They project a positive attitude with integrity, while being dedicated, reliable, trustworthy and respectful.



### ENERGY

REED staff have spark and vitality for building an industrious, enterprising and engaging atmosphere, all channeled toward achieving the REED Purpose.



### DETERMINATION

REED is busy, and hard-working REED people get things done through grit, tenacity and drive, with thoughtfulness toward others, while achieving high-quality results.



### SOLUTIONS FOCUS

REED thrives with creative, inventive team players who are proactive, innovative and discerning to solve problems and reach goals.



### SERVICE ORIENTATION

REED takes care of our whole community, fostering beneficial relationships with associates, customers, vendors and beyond. REED people exhibit courtesy and responsiveness along with a helpful, customer-focused outlook toward all.

## **FROM OUR FACTORY TO YOUR JOBSITE**

At Reed Manufacturing, we believe in hard work, in building things, in outperforming the competition, and in the doers—like you—that wake up daily to make it happen. Our tools are expertly designed for those who rise early and often, refuse to cut corners, and bravely lean into their challenges.

We have made it our business to design and manufacture tools that work as hard as you. We are a 5th-generation, family-owned company with over 125 years of craftsmanship and an unbreakable commitment to the future.

Thank you for your continued trust in Reed Manufacturing. We look forward to continuing to earn your trust as your go-to source for all your pipe tool needs.

*Scott K. Wright*

Scott Wright  
President



# SPECIAL FEATURES

Throughout the catalog, various symbols are used to help the reader identify key points:



**REED Exclusive Tool:** The tool is unique, available only from REED, offers operational cost savings or safety features, and at least one advantage to buying REED.



**REED Exclusive Features:** The tool has special features available only from REED. These meaningful features are advantages to buying REED.



**REED Exclusive Sizes:** The tool is available in certain capacities only from REED. These unique capacities are advantages to buying REED.



**REED Best Ever:** The tool has been improved over all previous versions. These continuous improvements are advantages to buying REED.



**REED Metric Sizes:** The tool has metric-only sizing. However, REED offers a wide variety of other tools to fit metric pipe since most tools suit a range of sizes.



**Why REED:** These statements explain why a REED tool is superior to others on the market, and can be used to compare REED products with the competition.



**New Tool:** Indicated by the "New" symbol. REED introduced the tool within the last 12 months.



**REED Extra Value:** The tool offers extra cost savings over the previous REED version – or the competitors'.



**Truck Freight Required:** These tools require truck freight due to large size or weight.

Note: Some products will be marked **GROSS WEIGHT**, which includes all components plus packaging.



**REED Video Training:** Numerous tools offer training videos through the REED website or YouTube. Scan the code to view the video on your mobile device.

## FIND A DISTRIBUTOR

To find the nearest REED Distributor, visit WHERE TO BUY on [www.reedmfgco.com](http://www.reedmfgco.com). Click on FIND A DISTRIBUTOR, enter your zip/postal code and search to identify nearby distributors, or click on SHOP ONLINE DISTRIBUTORS for a list of vetted, stocking distributors that also run online stores.

Alternatively, contact REED Sales or a REED Regional Manager or Manufacturer's Representative to find a distributor.

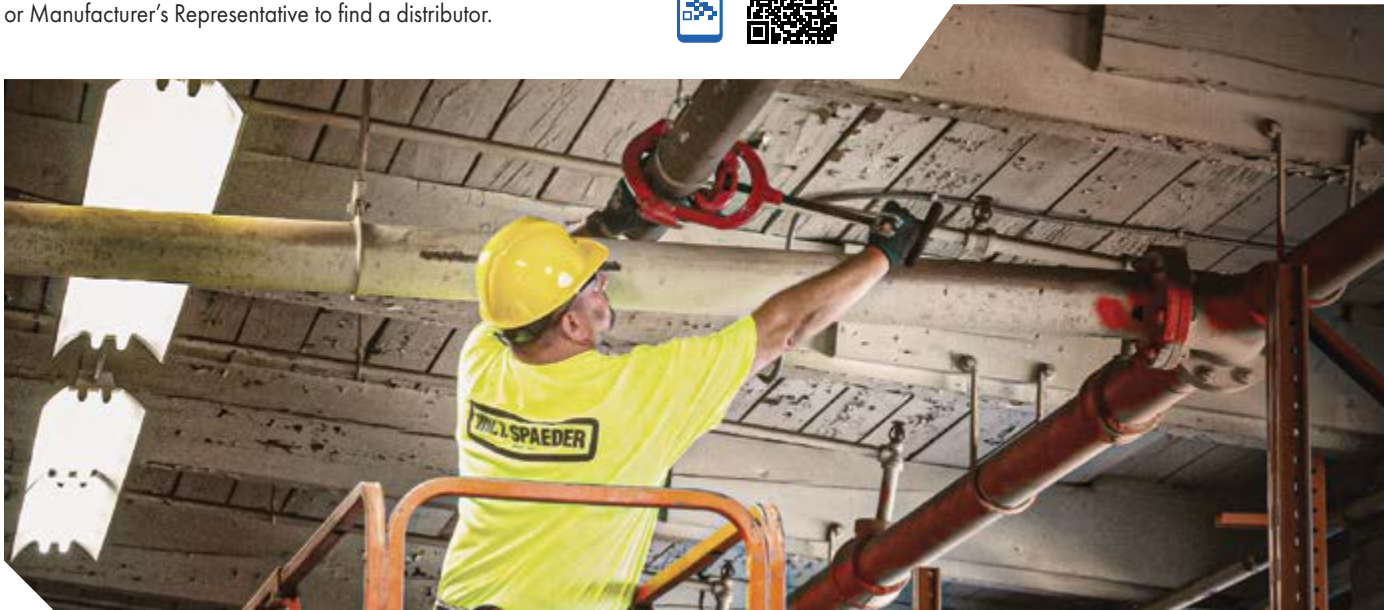



PIPE TOOLS & VISES  
SINCE 1896

**Phone:** 800.666.3691 (US/Canada) or +1 814.452.3691  
7:30 am–5:30 pm Eastern Time

**Fax:** +1 814.455.1697

**Shipping:** 1425 West 8th Street Erie, Pennsylvania 16502 USA

**Mailing:** P.O. Box 1321 Erie, Pennsylvania 16512 USA

**Email:** reedsales@reedmfgco.com

**Website:** www.reedmfgco.com

## REED WARRANTY



REED will repair or replace tools with any defects due to faulty materials or workmanship for one (1) year or five (5) years from the date of purchase, as applicable. This warranty does not cover part failure due to tool abuse, misuse, or damage caused where repairs or modifications have been made or attempted by non REED authorized repair technicians. This warranty applies only to REED tools and does not apply to accessories. This warranty applies exclusively to the original purchaser.

**One (1) year warranty:** Power units for pneumatic, electric, hydraulic and battery-powered tools have a one year warranty. This includes, but is not limited to REED pumps, universal pipe cutter motors, power drives, power bevel tools, threading machines, cordless batteries and chargers.

**Five (5) year warranty:** Any REED tool not specified under the one (1) year warranty above is warranted under the REED five (5) year warranty.

NO PARTY IS AUTHORIZED TO EXTEND ANY OTHER WARRANTY. NO WARRANTY FOR MERCHANTABILITY OR FITNESS FOR A PARTICULAR PURPOSE SHALL APPLY.

No warranty claims will be allowed unless the product in question is received freight prepaid at the REED factory. All warranty claims are limited to repair or replacement, at the option of REED, at no charge to the customer. REED is not liable for any damage of any sort, including incidental and consequential damages. This warranty gives you specific legal rights, and you may also have other rights which vary by state, province or country.

**Warranty Effective December 1, 2018**

# CONTENTS

## 1 CUTTERS & CUTTER WHEELS

Quick Release™ Tubing Cutters for Metal.....	9
Tubing Cutters.....	9
Tubing Cutters for Stainless Steel.....	10
Telescoping Tubing Cutters.....	10
Mini Tubing Cutters.....	10
C Cutters.....	11
Repair Kits for Tubing Cutters.....	11
2" Pipe Cutters.....	11
2" Pipe Cutters with Guides.....	12
Deburring Tools - Inner/Outer.....	12
Deburring Tools.....	12
Soil Pipe Cutters.....	13
Universal Pipe Cutters.....	14
Universal Pipe Cutter Blades.....	15
Filter-Regulator-Lubricator.....	15
Saw It® Pneumatic Reciprocating Saw.....	16
Power Hack Saw Blades.....	16
Hinged Pipe Cutters.....	17
Hinged Pipe Cutters with Helper Handles.....	17
Low Clearance Rotary Pipe Cutters.....	18
Rotary Pipe Cutters.....	18
Pipe Descalers.....	19
Pipe Reamer.....	19
Cutter Wheels.....	20-23

## 2 PLASTIC PIPE TOOLS

Quick Release™ Tubing Cutters for Plastic.....	27
Scissor Shears.....	27
Ratchet Shears.....	28
Plastic Pipe Saws.....	28
Internal Pipe Cutters.....	29
Plastic Pipe Joint Kits.....	29
DEB4 Deburr/Chamfer Tool.....	30
Cone Chamfer Tool - Drill Powered/Manual.....	30
Cone Deburring Tool.....	30
DEB1 Series Deburring Tools.....	31
DEB1 Series Deburring Tools - Drill Powered.....	31
Clean Ream Extreme® Plastic Pipe Fitting Reamers.....	32
Clean Ream Plus® Plastic Pipe Fitting Reamers.....	32
Bevel Boss® Cordless Pipe Bevelers.....	33
Pipe Bevelers.....	33
Chamfer Tools - Drill Powered.....	34

## 2 PLASTIC PIPE TOOLS

PEX Crimpers.....	34
PE Pipe Peeler.....	34
True Peel® PE Prep Tools.....	35
Static Grounding Devices.....	35
PE Squeeze Tools - Manual.....	36
PE Squeeze Tools - Small Diameter, Manual.....	36
Double Squeeze™ PE Squeeze Tools - Manual.....	37
PE Squeeze Tools - Hydraulic, Mid-Duty.....	37
Bear Hug™ PE Squeeze Tool - Hydraulic, Heavy-Duty.....	38
Guillotine Pipe Cutters.....	39
Universal Pipe Cutters for PE.....	39
PLAS In-Line Rotary Pipe Cutters.....	40
PLAS Hand-Over-Hand Rotary Pipe Cutters.....	40
Plastic Pipe Joiners for Solvent Cement Connections.....	41
Plastic Pipe Joiners for Gasketed Pipe.....	41

## 3 WATER SERVICES TOOLS

Feed Tap™ Drilling Machine.....	43
Drilling Machines.....	44-45
Direct Tapping Machine.....	46
Combination Drilling/Tapping Machines.....	47
PVC/PE Drilling Machines.....	47
Power Units for Tapping/Drilling.....	48
Manhole Hooks.....	48
Fiberglass Probe Rod.....	48
Cordless Power Drive for Tapping & Valve Exercising.....	49
Valve Operator.....	50
Utility Clutch.....	50
Valve & Curb Keys.....	51
Ratcheting Valve Keys.....	51
Meter Box & Curb Box Lid Keys.....	52
Corporation Stop Key Sockets.....	52
Torpedo Level for Waterworks.....	53
Flare Tools for PE Water Service Lines.....	53
PE Water Service Shut-off Tool.....	53
Standing Shut-off Tool.....	53
Hammer Flaring Tools for Copper Tubing.....	54
Rerounding Tools.....	54
Brass Hammer.....	54
Copper Shut-off Tools.....	55
Round It® Straightener/Rerounder.....	55
Pump Stick® Cordless Water Transfer Pump.....	56
Meter Pit Pump.....	56

## 4 THREADERS & DIES

R12+ Dropheads.....	58
R12+ Segmental Dies.....	58
R12+ Threader Sets.....	58
Universal Die Head.....	59
Universal Dies.....	59
Enclosed Dropheads.....	59
Enclosed Ratchet Threader Sets.....	60
Block Dies.....	60
Double Deep™ Oiler System.....	61
Threadguard Cutting Oil.....	61
5301PD Power Drive.....	62
700PD Power Drive.....	62
601PD Power Drive.....	63
Power Drive GFI.....	63

## 5 TEST PUMPS & GROOVERS

Drill Powered Hydrostatic Test Pumps.....	65
Electric Hydrostatic Test Pumps.....	65
Hydrostatic Test Pump.....	65
Combo Roll Groovers.....	66
Portable Roll Groovers.....	66

## 6 VISES

Tripod Pipe Vises.....	68-69
Pipe Jacks.....	70
Chain Vises.....	70
Field Pipe Vise.....	71
Yoke Pipe Vises.....	71
Utility Workshop Vises.....	71
Mid-Line Vises.....	72
Brass Vise Jaw Caps.....	72

## 7 WRENCHES & SOCKETS

Pipe Wrenches - Heavy-Duty.....	74
Chain Wrenches - Heavy-Duty.....	74
Aluminum Pipe Wrenches - Heavy-Duty.....	75
Strap Wrenches.....	75
Adjustable Wrenches.....	76
Comfort Grip - Adjustable Wrenches.....	76
Torque Wrenches for Cast Iron Soil Pipe.....	77
Square Drive Ratchet Wrenches.....	77
Thru-Bolt™ Utility Socket Sets.....	78
Extended Sockets.....	79
Thru-Bolt™ 4-in-1 Ratchet Wrenches.....	79
Thru-Bolt™ 2-in-1 Adjustable Ratchet Wrenches.....	80
Thru-Bolt™ 2-in-1 Dual Socket Wrenches.....	80
Basin Wrench.....	81
One Hand Wrenches.....	81
Comfort Grip - One Hand Wrench.....	81
Operator's Wrench.....	82
Valve Packing Wrenches.....	82
Valve Wheel Wrenches.....	82
Smooth Jaw Wrenches.....	83
Hydrant Wrenches.....	83
Ratcheting Hydrant Wrench.....	83

## 8 GENERAL PIPE WORKING TOOLS

Pump Stick® Cordless Water Transfer Pump.....	86
Mechanical Hot Tapping Machines.....	87
Tubing Benders.....	87
Stud Punch.....	88
Multi-Purpose Pipe Joiner.....	88
Torpedo Levels.....	88
Hack Saw & Blades.....	89
Water Pump Pliers.....	89
Positive Grip Pliers.....	89
Threaded Rod Cutters.....	90



## SECTION 1

# CUTTERS & CUTTER WHEELS

Quick Release™ Tubing Cutters for Metal  
Tubing Cutters  
Telescoping Tubing Cutters  
Mini Tubing Cutters  
C Cutters  
Repair Kits for Tubing Cutters  
2" Pipe Cutters  
Deburring Tools  
Soil Pipe Cutters  
Universal Pipe Cutters  
Filter-Regulator-Lubricator  
Saw It® Pneumatic Reciprocating Saw  
Power Hack Saw Blades  
Hinged Pipe Cutters  
Low Clearance Rotary Pipe Cutters  
Rotary Pipe Cutters  
Pipe Descalers  
Pipe Reamer  
Cutter Wheels





# Quick Release™ Tubing Cutters for Metal

## FEATURES

- Quick Release™ is a REED invention and still the industry standard for metal tubing cutters.
- Features include Quick Release™, quick advance, and manual advance, along with the ball detent wheel pin.
- Cuts aluminum, brass, copper, and steel tubing with standard wheel.
- Quick Release™ knob on sliding bar allows fast tool placement or removal.
- Simple cutter wheel change permits cutter use on a wide variety of pipe/tubing types.
- Built-in reamer in the knob on TC1Q, TC1.6Q, TC2Q.

Catalog No.	Item Code	Capacity		Cutter Wheel	Weight	
		in-nom.	actual O.D. mm		lbs	kg
TC1Q	03410	1/8 - 1 5/16	3 - 33	O	0.6	0.3
TC1.6Q	03416	1/4 - 1 5/8	6 - 42	O	0.95	0.4
TC2Q	03420	1/4 - 2 5/8	6 - 67	O	1.95	0.9
TC3Q	03430	3/8 - 3 1/2	10 - 90	30-40	2.5	1.1
TC3Q2558	03439	3/8 - 3 1/2	10 - 90	R2558	2.5	1.1
TC4Q	03440	1 7/8 - 4 1/2	48 - 114	30-40	2.8	1.3
TC5Q2558	03459	2 1/2 - 5	63 - 125	R2558	3.0	1.4
TC6Q	03460	4 - 6 5/8	102 - 168	30-40	3.9	1.8
TC8Q	04158	6 1/4 - 10	159 - 254	30-40	8.0	3.6

Quick Release™ Tubing Cutters for Plastic - p. 27



### WHY REED?

Quick Release™ cutter is a REED invention and still the industry standard for cutting both plastic pipe and metal tubing. REED uses a ball detent or threaded screw for the wheel pin which simplifies wheel changes. No other cutter on the market tracks or cuts as well.

# Tubing Cutters

## FEATURES

- Large grip knob for hand comfort during use.
- Internal reamer in T10 and T15 grip knob for operator convenience.
- For lighter weight, T20 features aluminum construction.

Catalog No.	Item Code	Pipe Capacity		Cutter Wheel	Weight	
		in-nom.	actual O.D. mm		lbs	kg
T10	03483	1/8 - 1	3 - 25	O*	0.9	0.4
T15	03485	3/16 - 1 1/4	4 - 32	O*	1.3	0.6
T20**	03487	5/8 - 2 1/8	15 - 54	O*	1.3	0.6

\*Ships with "O" wheel for copper. To cut plastic pipe, check the cutter wheel chart.

\*\*Approved for use at AWWA Tapping Contest



### WHY REED?

Sturdy T10, T15 and T20 models are long-lasting due to their reinforced construction.

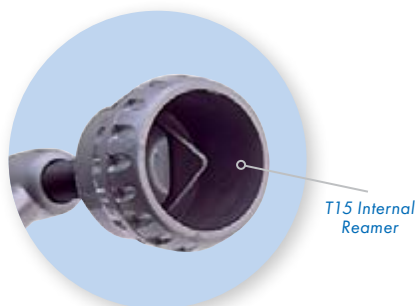

CUTTER WHEELS  
p. 20 - 23



PIPE TOOLS & VISES  
SINCE 1896



## Tubing Cutters for Stainless Steel

### FEATURES

- Specialized steel cutter wheels are designed for toughness and heat dissipation.
- Ergonomic grip knob on T10SS, T15SS and T20SS cutters.
- Long cutter wheel life as cutter wheels are built for stainless steel.
- Telescoping TC11SS is a great choice for tight spaces.

Catalog No.	Item Code	Pipe Capacity		Cutter Wheel	Weight	
		in-nom.	actual O.D. mm		lbs	kg
T10SS	03476	1/8 - 1	3 - 25	OSS	0.9	0.4
T15SS	03477	3/16 - 1 1/4	4 - 32	OSS	1.4	0.6
T20SS	03479	5/8 - 2 1/8	15 - 54	OSS	1.5	0.7
TC11SS*	03481	1/8 - 1 1/8	3 - 28	75046	0.7	0.3

\*Includes spare cutter wheel.



Only REED offers such a wide variety of professional-quality cutters with wheels for stainless installed. No more extra cost and hassle of early replacement of the first wheel!

## Telescoping Tubing Cutters

### FEATURES

- Easy action, fold-out reamer, grooved rollers, and spare cutting wheel.
- Telescoping cutter design is a great choice for tight spaces.
- Enclosed feed screw keeps cutter at a consistent size throughout the cut.



Catalog No.	Item Code	Pipe Capacity		Cutter Wheel**	Weight	
		actual O.D. in.	actual O.D. mm		lbs	kg
TC14	03475	1/4 - 1 3/8	6 - 35	73505	1.1	0.5
TC11	03480	1/8 - 1 1/8	3 - 28	75015	0.7	0.3

\*\* Standard wheel listed. Order heavy-duty wheel separately per the cutter wheel chart.

## Mini Tubing Cutters

### FEATURES

- For use in extremely tight places.
- Smooth, rounded body contour for comfortable grip.



Catalog No.	Item Code	Pipe Capacity		Cutter Wheel	Cutter Swing	Weight	
		actual O.D. in.	actual O.D. mm			lbs	kg
<sup>Δ</sup> MC1	03470	1/8 - 5/8	3 - 15	32633	1 1/4"	0.2	0.1
<sup>Δ</sup> MC2	03490	1/8 - 15/16	3 - 24	345T	1 11/16"	0.3	0.1
<sup>Δ</sup> MC2GRIP	03493	1/8 - 15/16	3 - 24	345T	1 11/16"	0.4	0.2
<sup>Δ</sup> MC3	03495	1/8 - 1 1/8	3 - 28	73505	1 7/8"	0.4	0.2



Large, high-torque knobs on the MC2GRIP and MC3 provide easy feeding. MC1 needs only 1 1/4" radial clearance, featuring the smallest cutting diameter in the industry.

CUTTER WHEELS  
p. 20 - 23



# C Cutters

## FEATURES

- Compact c-shape means no handle swing space is required.
- Easy-to-grip cutter easily snaps on to copper tubing for a quick, clean cut.
- Spring-loaded cutter self-feeds on K, L and M copper and CTS CPVC.
- Consistent pressure is maintained as the tool is turned manually around the tubing.

Catalog No.	Item Code	Pipe Capacity		Application	Weight	
		in-nom.	actual O.D. mm		lbs	kg
TCK3SL	03402	1/2, 3/4, 1	15.9, 22.2, 28.6	Copper, CPVC	1.9	0.9
TC5075SLR	03403	1/2 - 3/4	15 - 22	Copper, CPVC	0.35	0.16
TCK50SLR	03412	1/2	15.9	Copper, CPVC	0.4	0.17
TCK75SLR	03413	3/4	22.2	Copper, CPVC	0.5	0.22
TCK1SLR	03414	1	28.6	Copper, CPVC	0.42	0.19



# Repair Kits for Tubing Cutters

## FEATURES

- Great choice for distributor repair counters or contractor maintenance departments.
- Get contractors back to work with these common spare parts for tubing cutters and shears.

Catalog No.	Item Code	Weight	
		lbs	kg
1-2 PARTS	03009	0.13	0.1
3-4-6 PARTS	03010	0.21	0.1
RPRKIT	03011	5.5	2.5
T10-T15-T20 PARTS	03014	0.19	0.1



# 2" Pipe Cutters

## FEATURES

- Cutters with thin profile, sharp REED cutter wheels allow shorter handles for work in smaller spaces.
- Wide rollers help create square cuts.
- Leaves no burr, which is great for threading jobs.

Catalog No.	Item Code	Capacity		Cutter Wheel	Length		Weight	
		in-nom.	actual O.D. mm		in	mm	lbs	kg
2-1*	03320	1/8 - 2	10 - 63	2RBS	15.8	400	6.9	3.1
2-3*	03305	1/8 - 2	10 - 63	2RBS	15.8	400	6.8	3.1
2-4*	03335	1/2 - 2	21 - 63	2RBS	14.3	362	6.8	3.1

\*Ships with 2RBS wheel for steel/stainless steel.  
2RBHD heavy-duty wheels available for steel and stainless steel.

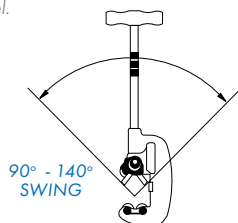

## WHY REED?

REED's wheel pin design is unique. Quick wheel or roller change as the ring on the top of the wheel pin makes it convenient to find, center and fully insert the pin.



CUTTER WHEELS  
p. 20 - 23



PIPE TOOLS & VISES  
SINCE 1896



### WHY REED?

Guide bars on 2-4WG are exclusive to REED and the best way to get a square cut on stainless steel and corroded pipe. The guides make the cutter more stable on the pipe, thus reducing motion wear on the wheels.

## 2" Pipe Cutters with Guides

### FEATURES

- Spring-tensioned guide bars square the cutter to the pipe.
- Guides also help remove scale and grit from the pipe.
- Four cutter wheels yield quick cuts.
- Designed for a square cut since the bars hold the cutter square to the pipe during the cutting process.
- Cutters work on steel, stainless steel, galvanized steel or cast iron pipe, depending on the installed cutter wheels.

Catalog No.	Item Code	Capacity		Cutter Wheel	Length		Weight	
		in-nom.	actual O.D. mm		in	mm	lbs	kg
2-4WG*	03338	1/2 - 2	21 - 63	2RBS	14.3	362	7.2	3.3

\*Ships with 2RBS wheel for steel/stainless steel.

2RBHD heavy-duty wheels available for steel and stainless steel.

CUTTER WHEELS  
p. 20 - 23

## Deburring Tools - Inner/Outer

### FEATURES

- Deburr inner and outer diameters with one tool.
- Knurled hand grip keeps tool secure in operator's hand.
- Used for water service lines, copper pipe installations, plumbing lines, radiant heating and gas lines.



DEB200

Catalog No.	Item Code	Capacity		Weight	
		in-nom.	actual O.D. mm	lbs	kg
DEB200	04431	3/8 - 2 CTS I.D./O.D. 3/8 - 1 1/2 IPS I.D./O.D.	10 - 54 I.D./O.D.	1.1	0.5



DEB200 internal use



DEB200 external use

## Deburring Tools

### FEATURES

- Long-lasting, hardened tool steel deburring blade.
- Pocket-sized models are easy to carry.
- Tools deburr aluminum, copper and steel tubing.



DEB0

DEB3

Catalog No.	Item Code	Pipe Capacity in-nom.	Weight	
			lbs	kg
DEB0	04434	unlimited	0.1	0.05
DEB3*	04437	unlimited	0.1	0.05

\*Reamer replacement blade #94437 fits DEB3, TC1.6Q and TC14 cutters.



# Soil Pipe Cutters

## FEATURES

- Great for gray water applications.
- Soil Pipe Cutters apply chain pressure to snap the pipe.
- REED innovations have improved upon the original design.
- Captured screw in SC49 assures proper alignment.

1/2" Ratchet Wrench ships with all SC49 Cutters.

SCFR Wrench

Captured Screw



## RATCHETING

Catalog No.	Item Code	Type	Capacity		Length		Weight	
			in-nom.	actual O.D. mm	in	mm	lbs	kg
△ SC49-6*	08049	Ratchet	1 1/2 - 6	38 - 160	26	660	17.6	8.0
△ SC49-8*	08050	Ratchet	1 1/2 - 8	38 - 212	26	660	19.4	8.8
△ SC49-10*	08051	Ratchet	1 1/2 - 10	38 - 268	26	660	21.2	9.6
△ SC49-12*	08052	Ratchet	1 1/2 - 12	38 - 317	26	660	23.0	10.5
△ SC49-15*	08053	Ratchet	1 1/2 - 15	38 - 403	26	660	24.8	11.3

\*1/2" Male Ratchet Wrench (#40208) included with SC49 cutters

## SINGLE STROKE

Catalog No.	Item Code	Type	Capacity		Length		Weight	
			in-nom.	actual O.D. mm	in	mm	lbs	kg
△ SC59-6	08059	Single Stroke	1 1/2 - 6	38 - 160	43	1,092	23.8	10.8
△ SC59-8	08060	Single Stroke	1 1/2 - 8	38 - 212	43	1,092	25.6	11.6
△ SC59-10	08061	Single Stroke	1 1/2 - 10	38 - 268	43	1,092	27.4	12.5
△ SC59-12	08062	Single Stroke	1 1/2 - 12	38 - 317	43	1,092	29.2	13.3
△ SC59-15	08063	Single Stroke	1 1/2 - 15	38 - 403	43	1,092	31.0	14.1

### Maximum Pipe Capacities (determined by maximum pressure applied):

- Extra heavy cast iron soil pipe..... 2 - 4" (62 - 125 mm)
- Service weight cast iron soil pipe..... 2 - 8" (62 - 212 mm)
- Concrete pipe ..... 4 - 6" (125 - 160 mm)
- No-Hub® cast iron soil pipe..... 1 1/2 - 8" (38 - 212 mm)
- Clay pipe ..... 2 - 15" (62 - 403 mm)

Extension chains available to increase capacity of smaller cutters.

## ACCESSORIES

Catalog No.	Item Code	Description
SCEXT	40336	10" Chain Extension with 8 Pitches at 1.25" per Pitch
TW516	02298	5/16" Torque Wrench
TW38	02300	3/8" Torque Wrench
SCFR	40208	1/2" Male Square Drive Wrench



## WHY REED?

First introduced by REED, the captured screw makes the SC49 close-quarter soil pipe cutters both easy to use and less costly. The screw does not have to be manipulated into place which reduces screw and cutter breakage.





PIPE TOOLS & VISES  
SINCE 1896



UPC  
cutting PE



UPC636A  
on ductile iron

**EXCLUSIVE  
TOOL**



UPC636A

UPC616A

## Universal Pipe Cutters

### FEATURES

- Able to cut 6" - 48" nominal diameter (150-1300 mm actual O.D.) ductile iron, cast iron, clay, concrete, steel, PVC or PE pipe.
- Cut large diameter pipe in a controlled way, with pneumatic power.
- Basic unit can be adapted to a variety of uses, depending on blade selected.

Catalog No.	Item Code	Pipe Capacity		Gross Weight**	
		in-nom.	actual O.D. mm	lbs	kg
△ UPC636A*	07510	6 - 36	150 - 1000	131	59.5
△ UPC648A*	07511	6 - 48	150 - 1300	138	62.7
△ UPC616A*	07512	6 - 16	150 - 450	89	40.5
△ UPC836APE*	07517**	8 - 36	200 - 1000	101	45.9
△ UPC848APE*	07518**	8 - 48	200 - 1300	106	48.2

\*Model ships freight.

\*\*UPC836APE, UPC848APE come with two blades. Full details on p. 39  
Pipe Descalers p. 19

### MUST ORDER REQUIRED BLADES SEPARATELY.

#### Universal Pipe Cutter Motor Specifications:

Air Flow Required ..... 50 cu. ft./min (1.4 cu. m/min.)  
Pressure ..... 90 PSI Maximum (6 BAR)  
Horsepower Generated ..... 1.7 HP  
Maximum RPM ..... 3675  
Shut-Off ..... 3/4" Ball Valve  
Air Supply Fittings ..... 3/4" Dixon "Air King" Coupling

### ACCESSORIES

Catalog No.	Item Code	Description
UPHKS	40156	Hex Key Set
UPNUT	97543	Arbor Locknut
UPRELPN	97545	Release Pins
UPHOOK	97546	Chain Hooks
UPCLA	97561	Long Arbor
UPHOSE	97581	Water Tank Hose System
△ UPOIL	97583	Air Line Oil, 16 oz. bottle
UPFGRSGUN	97587	Grease Gun
UPGREASE	97588	Gear Grease, 2 oz.
UPWEDGE	97589	Wedges
UPWRENCH	97590	Arbor Wrench
UPDRESS	97595	Diamond Blade Sharpening Stone
AFRK	47506	Air Filter Rebuild Kit
△ UPWTRTK	40159	Water Tank with Cart, 6 gallon
UPCBG	07509	Blade Guard Assembly - up to 8" Diameter Blade
UPCBGA	97559	Blade Guard Assembly - up to 7.25" Diameter Blade

### SERVICE

UPC motor reconditioning/refurbishing is available.  
Complete UPC cutters can also be reconditioned/refurbished.  
BEFORE shipping items, contact REED.

### WHY REED?

REED UPC is lightweight; cuts fast; requires only 12" (300 mm) clearance around the pipe; provides a square cut virtually every time; and can be operated underwater. It is by far the safest, easiest and fastest power cutter to setup, operate and maintain, which nets a low operating cost.



# Universal Pipe Cutter Blades

## FEATURES

- Choose the best blade for the application.

Catalog No.	Item Code	Description	Pipe Diameter		Application
			in	mm	
UPCARB4	97510	4" Blade cuts up to 2 <sup>3</sup> / <sub>32</sub> " (18.3 mm) wall thickness	6	150	PVC
△ UPCBPVC	97511	PVC Bevel Cutter Accessory	6 - 48	150 - 1300	PVC
UPCARB6	97514	6" Blade cuts up to 1 2 <sup>3</sup> / <sub>32</sub> " (43.7 mm) wall thickness	8 - 48	200 - 1300	PVC
△ UPCSTEEL4	97519	Carbide-tipped 4" Blade cuts up to 1/2" (12.7 mm) STEEL wall thickness	6 - 8	150 - 200	Steel
		Carbide-tipped 4" Blade cuts up to 2 <sup>3</sup> / <sub>32</sub> " (18.3 mm) PE wall thickness	6 - 8	150 - 200	PE
△ UPCSTEEL6	97520	Carbide-tipped 6" Blade cuts up to 1/2" (12.7 mm) STEEL wall thickness	8 - 48	200 - 1300	Steel
		Carbide-tipped 6" Blade cuts up to 1 2 <sup>3</sup> / <sub>32</sub> " (43.7 mm) PE wall thickness	8 - 48	200 - 1300	PE
△ UPCPE8	97521	8" Blade cuts up to 2 2 <sup>3</sup> / <sub>32</sub> " (69 mm) wall thickness.	26 - 48	660 - 1300	PE
UPCDIA4	97529	4" UPC Blade, Diamond Grit Edge, cuts up to 2 <sup>3</sup> / <sub>32</sub> " (18.3 mm) wall thickness	6 - 8	150 - 200	Cast Iron, Pit Cast, Ductile, Iron, Clay, Concrete
UPCDIA6	97525	6" UPC Blade, Diamond Grit Edge, cuts up to 1 2 <sup>3</sup> / <sub>32</sub> " (43.7 mm) wall thickness	8 - 48	200 - 1300	Cast Iron, Pit Cast, Ductile, Iron, Clay, Concrete



UPCSTEEL6



UPCARB4



UPCDIA6



UPCBPVC

**CAUTION:** When cutting steel, ductile iron or cast iron, the UPC can produce sparks. When cutting steel pipe with the steel "DIA" blades, sparks are expected. Because of the sparks, the UPC cannot be used for cold cuts. When cutting PE, the UPC may cause a build-up of static electricity. Do not use the UPC saw in-line on potentially explosive or otherwise dangerous situations. The line must be verified as completely purged of any flammable vapor or liquid.

# Filter-Regulator-Lubricator

## FEATURES

- Maximize tool efficiency by using clean air.
- Protect pneumatic motors from contamination by using an FRL.
- Failure to use an FRL may result in premature motor failure and will negate warranty.

Catalog No.	Item Code	Weight	
		lbs	kg
FRL	97591	12.5	5.7



FRL

# REED REGISTERED & TRADEMARKED

Bear Hug™

Bevel Boss®

Clean Cut®

Clean Ream Extreme®

Clean Ream Plus®

Cutter Wheel Headquarters™

Double Deep™

Double Squeeze™

Feed Tap™

Pump Stick®

Quality First®

Quick Release™

Round It®

Saw It®

Thru-Bolt™

True Peel®



PIPE TOOLS & VISES  
SINCE 1896

# Saw It® Pneumatic Reciprocating Saw



SAWITSD2

Safety Dead Man Switch

## FEATURES

- Saw It® pneumatic reciprocating saw is a good choice for cutting plastic and steel pipe in hard-to-reach places.
- Safety deadman switch for instant off when throttle is released.
- Pneumatic (air) motor eliminates electric shock hazard.
- No fumes like gas powered cut-off saws.
- Site preparation requires less excavation than other tools.
- Continues to function underwater, in severe in-ditch environments, unlike electric or gas powered tools.
- Saw It® Vise and Saw It® Blade Guides should be added for extra stability.
- Power Hack Saw Blades sold separately.

Catalog No.	Item Code	Pipe Diameter		Maximum Power	Air Consumption	Weight	
		in-nom.	actual O.D. mm			lbs	kg
SAWITSD2	07620	up to 24" max.	up to 610 max.	2.0 HP, 1.5 kW	40 cfm @ 90 psi (18.9 l/s @ 6.2 BAR)	21.5	9.8

SAWITVISE

FRL  
p. 15



Great for tight clearance work on process piping



SAWITBG21

## SAW IT® BLADE GUIDES

Catalog No.	Item Code	Fits	Capacity
SAWITBG21	04602	21" Long Blades	Up to 12" Pipe
SAWITBG30	04603	30" Long Blades	Up to 20" Pipe

## SAW IT® VISE

Catalog No.	Item Code	Capacity*		Weight	
		in-nom.	actual O.D. mm	lbs	kg
SAWITVISE	04600	4 - 12	102 - 305	14.0	6.4

\*Capacity is dependent on blade and chain extensions.

## SAW IT® VISE CHAIN EXTENSIONS

Catalog No.	Item Code	Description	Length	
			in	mm
CHEXT6	40628	Adds 6" diameter increment	19.375	492
CHEXT12	40629	Adds 12" diameter increment	42	1067

## WHY REED?

This saw is safer and cuts straighter than a gas-powered chop saw. The Saw It® Vise allows the saw to pivot straight into the pipe, giving the operator better control over the cut. Used together, this saw is EASY to handle.



# Power Hack Saw Blades

## FEATURES

- Cut copper, steel, stainless steel, aluminum, and harder plastics like PVC and ABS.
- Blades from 8" - 30" long available.
- Wavy set teeth provide clearance for the blade to pass through the cut.



Z1614

Z1214

## WHY REED?

Extra blade depth (1 3/8") and the Matrix HSS cutting edge guarantee superior performance. The bimetal construction reduces the tendency of solid HSS blades to shatter.

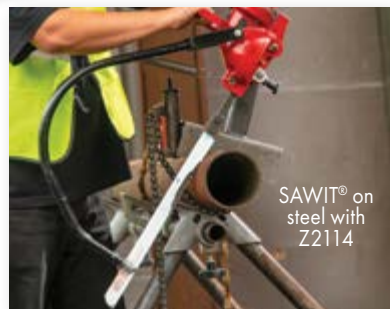

SAWIT® on steel with Z2114

Catalog No.	Item Code	Length/Width/Thickness		Teeth Per Inch
		in-nom.	mm	
Z814	04478	8 x 1 3/8 x 0.062	200 x 35 x 1.6	14
Z1014	04479	10 x 1 3/8 x 0.062	250 x 35 x 1.6	14
Z1214	04494	12 x 1 3/8 x 0.062	300 x 35 x 1.6	14
Z1614	04495	16 x 1 3/8 x 0.062	400 x 35 x 1.6	14
Z2114	04496	21 x 1 3/8 x 0.062	533 x 35 x 1.6	14
Z2414	04497	24 x 1 3/8 x 0.062	600 x 35 x 1.6	14
Z3014	04498	30 x 1 3/8 x 0.062	760 x 35 x 1.6	14
Z1608	04499	16 x 1 3/8 x 0.062	400 x 35 x 1.6	8
Z2108	04597	21 x 1 3/8 x 0.062	533 x 35 x 1.6	8

NOTE: Blade length should be at least 6" more than the O.D. of the pipe. 14 TPI (teeth per inch) work best on at least 1/8" wall thickness. 8 TPI work best on walls at least 3/16" thick. Choose 8 teeth per inch for softer materials like plastic.



# Hinged Pipe Cutters

## FEATURES

- Pipe cutter with hinge is a REED invention that needs only 4" (102 mm) of clearance around pipe.
- Efficient handle swing of only 90° to 110°.
- Opens with hinge to place 4-wheel cutter around the pipe.
- Can be used anywhere - in the ditch, underwater, overhead, in racks of pipe!

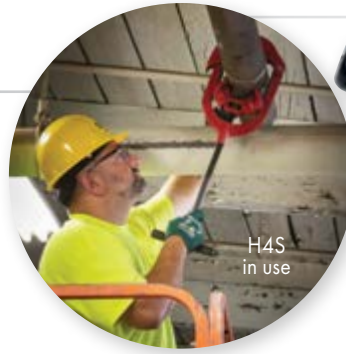

Catalog No.	Item Code	Pipe Capacity		Length		Weight	
		in-nom.	actual O.D. mm	in	mm	lbs	kg
H21/2S*	03110	1 - 2 1/2	32 - 76	17	419	7.2	3.3
H21/2I*	03112	1 - 2 1/2	32 - 76	17	419	7.2	3.3
H21/2X*	03114	1 - 2 1/2	32 - 76	17	419	7.2	3.3
Δ H4S	03120	2 - 4	60 - 125	22	559	12.8	5.8
Δ H4I	03122	2 - 4	60 - 125	22	559	12.8	5.8
Δ H4X	03124	2 - 4	60 - 125	22	559	12.8	5.8
Δ H6S**	03130	4 - 6	114 - 182	28	711	19.4	8.8
Δ H6I	03132	4 - 6	114 - 182	28	711	19.4	8.8
Δ H6X	03134	4 - 6	114 - 182	28	711	19.4	8.8
Δ H8S**	03140	6 - 8	168 - 240	32	813	24.4	11.1
Δ H8I	03142	6 - 8	168 - 240	32	813	24.4	11.1
Δ H8X	03144	6 - 8	168 - 240	32	813	24.4	11.1
Δ H8XX	03146	6 - 8	168 - 240	32	813	24.4	11.1
Δ H12S	03150	8 - 12	219 - 356	34	864	34.9	15.9
Δ H12I	03152	8 - 12	219 - 356	34	864	34.9	15.9
Δ H12X	03154	8 - 12	219 - 356	34	864	34.9	15.9
Δ H12XX	03156	8 - 12	219 - 356	34	864	34.9	15.9

### \*EXCLUSIVE SIZE

\*\* H6S with HS6 cutter wheel can be used to cut 4" - 6" copper, Type K & L.  
H8S with HS8-12 cutter wheel can be used to cut 6" - 8" copper, Type K & L.

S Models for steel/stainless steel / I Models for cast/ductile iron  
X Models for Sch. 80 steel / XX Models for Sch. 100 steel



# Hinged Pipe Cutters with Helper Handles

## FEATURES

- Manual cutter, with hinge opening, fits around pipe securely and uses four cutter wheels.
- "Helper handle" allows two people to make a team effort for bigger, tougher cuts.
- Efficient handle swing of only 90° to 110°.

Catalog No.	Item Code	Pipe Capacity		Assembled Length		Weight	
		in-nom.	actual O.D. mm	in	mm	lbs	kg
Δ H6SHH	03138	4 - 6	114 - 182	51	1295	21.8	9.9
Δ H8SHH	03148	6 - 8	168 - 240	58	1473	23.6	10.7
Δ H12SHH	03158	8 - 12	219 - 356	63	1600	36.5	16.6
Δ H6XHH	03139	4 - 6	114 - 182	51	1295	21.8	9.9
Δ H8XHH	03147	6 - 8	168 - 240	58	1473	23.6	10.7
Δ H12XHH	03157	8 - 12	219 - 356	63	1600	36.5	16.6
Δ H8XXHH	03149	6 - 8	168 - 240	58	1473	23.6	10.7
Δ H12XXHH	03159	8 - 12	219 - 356	63	1600	36.5	16.6

S Models for steel/stainless steel / X Models for Sch. 80 steel / XX Models for Sch. 100 steel

✓ IDEAL FOR CUTTING WELL CASING



✓ SCH. 80 X MODELS

✓ SCH. 100 XX MODELS

CUTTER WHEELS p. 20 - 23



PIPE TOOLS & VISES  
SINCE 1896

# Low Clearance Rotary Pipe Cutters

## FEATURES

- Low profile design requires only 5 inch (127 mm) clearance.
- Four cutter wheel design is excellent for cold cuts.
- Pipe snaps off squarely once the operator completes the cut.



Catalog No.	Item Code	Length/Width/Thickness			Length		Weight	
		Steel in-nom.	Cast & Ductile Iron in-nom.	actual O.D. mm	in	mm	lbs	kg
LCRC4X	03304	2 - 4	-	60 - 125	19	483	12.3	5.6
LCRC4I	03306	-	2 - 4	60 - 125	19	483	12.3	5.6
LCRC4S	03307	2 - 4	-	60 - 125	19	483	12.3	5.6
Δ LCRC8I	03308	-	6 - 8	159 - 246	58	1473	42.6	19.4
Δ LCRC8S	03309	6 - 8	-	159 - 246	58	1473	42.6	19.4
Δ LCRC8X	03311	6 - 8	-	159 - 246	58	1473	42.6	19.4
Δ LCRC12I	03312	-	10 - 12	266 - 358	61	1549	50	22.7
Δ LCRC12S	03313	10 - 14	-	266 - 358	61	1549	50	22.7
Δ LCRC12X	03314	10 - 14	-	266 - 358	61	1549	50	22.7
Δ LCRC16I	03316	-	14 - 16	368 - 462	66	1664	60	27.3
Δ LCRC16S	03317	16 - 18	-	368 - 462	66	1664	60	27.3
Δ LCRC16X	03318	16 - 18	-	368 - 462	66	1664	60	27.3

S Models for steel/stainless steel  
I Models for cast/ductile iron  
X Models for Sch. 80 steel  
XX Models for Sch. 100 steel



## WHY REED?

Rotary Pipe Cutters are a REED invention! Cut pipe safely, easily, quickly and at a low cost. Provide a square cut and can be used in close quarters anywhere – in the ditch, underwater, in noise-free zones, overhead, in racks of pipes, etc. With proper care and new cutter wheels, Rotary Pipe Cutters last for decades.

EXCLUSIVE TOOL

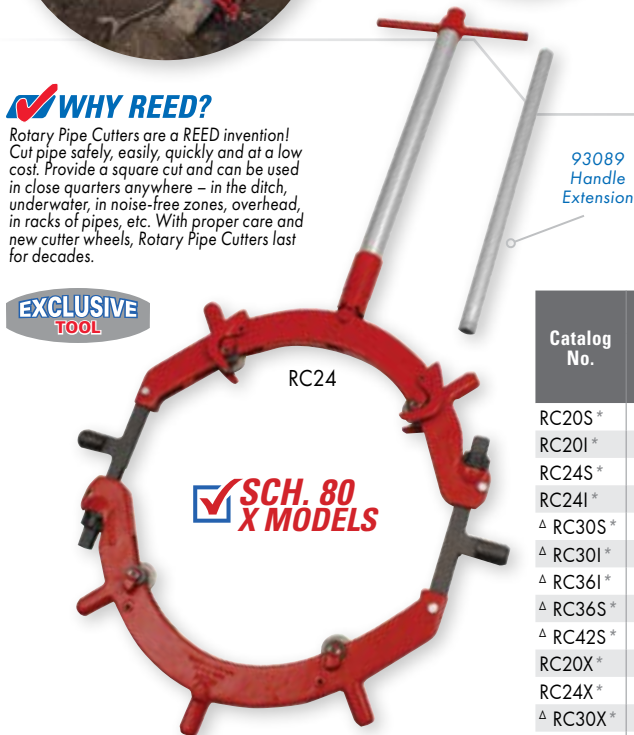

# Rotary Pipe Cutters

## FEATURES

- Pipe snaps off squarely once the operator completes the cut.
- Four-wheel cutters are excellent for cold cuts.
- Designed to cut large diameter pipe.

Catalog No.	Item Code	Length/Width/Thickness			Clearance		Length		Weight	
		Steel in-nom.	Cast & Ductile Iron in-nom.	actual O.D. mm	in	mm	in	mm	lbs	kg
RC20S*	03240	20 - 22	-	476 - 572	8	204	106	2680	89	40.5
RC20I*	03242	-	18 - 20	476 - 572	8	204	106	2680	89	40.5
RC24S*	03250	24 - 26	-	584 - 660	8	204	111	2807	107	48.6
RC24I*	03252	-	22 - 24	584 - 660	8	204	111	2807	107	48.6
Δ RC30S*	03260	28 - 34	-	698 - 864	11.8	300	96	2438	283	128.6
Δ RC30I*	03262	-	30	698 - 864	11.8	300	96	2438	283	128.6
Δ RC36I*	03263	-	30	813 - 915	11.8	300	96	2438	295	134.1
Δ RC36S*	03264	32 - 36	-	813 - 915	11.8	300	96	2438	295	134.1
Δ RC42S*	03265	40 - 42	-	1016 - 1067	10.5	267	108	2743	325	147.7
RC20X*	03270	20 - 22	-	476 - 572	8	204	106	2680	89	40.5
RC24X*	03271	24 - 26	-	584 - 660	8	204	111	2807	107	48.6
Δ RC30X*	03272	28 - 34	-	698 - 864	11.8	300	96	2438	283	128.6
Δ RC36X*	03273	32 - 36	-	813 - 915	11.8	300	96	2438	295	134.1
Δ RC42X*	03274	40 - 42	-	1016 - 1067	10.5	267	108	2743	325	147.7

S Models for steel/stainless steel  
I Models for cast and ductile iron  
X Models equipped with RCX cutter wheels and special RC8-30XR outboard rollers. Larger blade exposure (0.800" / 20.3 mm) of RCX cutter wheels penetrates thick pipe walls of steel, heavy wall steel and stainless steel.

Wheels for same size cutters are interchangeable. Recommend only REED cutter wheels be used.

\*Model ships freight.



# Pipe Descalers

## FEATURES

- Faster and more effective than chisels, chains or files.
- Needs only 2" of clearance around the pipe.
- For removing tough dirt and debris quickly, choose the sharp scrapers on the DS12 and DS36 chain descalers.



Catalog No.	Item Code	Type	Pipe Capacity		Length		Weight	
			in-nom.	actual O.D. mm	in	mm	lbs	kg
DS12	08000	Steel	3 - 12	70 - 300	32	810	5.7	2.6
DS36	08006	Steel	3 - 36	70 - 910	44	1110	8.2	3.7
DS12B	08008	Belt	3 - 12	70 - 300	45	1143	4.2	1.9

## REPLACEMENT BELT

Catalog No.	Item Code	Type	Length		Weight	
			in	mm	lbs	kg
DS12BRB	98008	Belt fits REED DS12B or Wheeler-Rex® 1300	45	1143	3.0	1.4



# Pipe Reamer

## FEATURES

- Self-feeding, spiral pipe reamer starts easily into pipe.
- Dual pawls for extra tooth engagement.
- Durable, hardened tool steel cone on pipe reamer for maximum cutting life.
- Manual tool designed for pipe reaming efficiency.

Catalog No.	Item Code	Pipe Capacity		Weight	
		in-nom.	actual O.D. mm	lbs	kg
2-71	06060	1/8 - 2	3 - 50	6.7	3.0



2-71

### ✓ WHY REED?

This REED invention has two pawls for faster action and for work in tight places – requires half the handle swing space of competitive reamers.

**EXCLUSIVE FEATURE**

# FIND THE RIGHT CUTTER

Try the CUTTER FINDER on [www.reedmfgco.com](http://www.reedmfgco.com). By entering the pipe material and size, tool users can find with ease all the possible REED cutters that fit that pipe. This online search tool is open in all of REED's main website languages: English, Spanish, French, German, Chinese, Russian and Japanese.



# CUTTER WHEELS

## **DESIGNED FOR PERFORMANCE**

Thinner is better! REED wheels cut easier and more precisely with less burr.

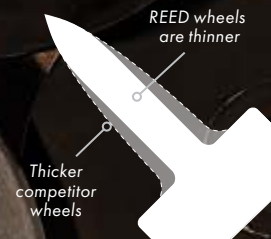

## REED CUTTER WHEELS

All REED cutter wheels are made from high shock-resistant tool steel, while competitive wheels are made from carbon steel or still lower quality tool steel. By using this higher quality, raw material, REED cutter wheels can be made thinner and can therefore cut pipe more easily and leave less burr. Also, because of their higher quality, certified material, only REED wheels can be heat-treated for the perfect balance between hardness and toughness to make the wheels resist breakage and last longer.

REED pioneered the development of wheels for plastic pipe and today has the widest variety and highest quality wheels for various types and wall thicknesses of plastic pipe and tubing.

REED offers the largest cutter wheel line for all types of pipe, tubing and conduit. REED wheels are the best value for use in REED cutters, or in the cutters of any other manufacturer.

**MORE HIGH QUALITY WHEELS FOR MORE CUTTERS AND BRANDS THAN ANY OTHER MANUFACTURER!**

## REED 2-Pack Replacement Cutter Wheels

Catalog No.	Item Code	Standard Pack	REED Cutter	Blade Exposure		Application
				in	mm	
<b>FOR TUBING CUTTERS - METAL</b>						
2PK-TCKCW	63376	1	TC3SL; TC5075SLR; TCK50SLR; TCK75SLR; TC1SLR; TC50SL; TC75SL; TC1SL; TC50SLR; TC75SLR; TC1SLR	0.101	2.6	Copper; CTS; CPVC
2PK-OSS	63655	1	TC1Q; TC1.6Q; TC2Q; T10; T15; T20	0.160	4.1	Stainless Steel
2PK-OCSST-2	63659	1	TC1.6Q; TC1.6RGT; TC2Q; TC2QRGT	0.281	7.1	CSST Tubing
2PK-O	63660	1	TC1Q; TC1.6Q; TC2Q; T10; T15; T20; RT15T1; RT15T2; RT15T3; RTC1.1; RTC1.4	0.180	4.6	Copper; Aluminum; Brass; Steel Tubing
2PK-32633	63661	1	MC1	0.127	3.2	Copper; Aluminum; Brass; Steel Tubing
2PK-75015	63662	1	TC11; TC17	0.125	3.2	Copper; Aluminum; Brass; Steel Tubing
2PK-75046	63663	1	TC11; TC17	0.125	3.2	Stainless Steel
2PK-30-40	63665	1	TC3Q; TC4Q; TC5Q; TC6Q; TC8Q	0.250	6.4	Copper; Aluminum; Brass; Steel Tubing
2PK-345T	63666	1	MC2	0.146	3.7	Copper; Aluminum; Brass
2PK-R4546	63668	1	MC2	0.146	3.7	Copper; Aluminum; Brass
2PK-R2558	63670	1	TC3Q; TC4Q; TC5Q; TC6Q; TC8Q	0.188	4.8	Muffler Systems Tubing
2PK-30-40SS	63671	1	TC3Q; TC4Q; TC5Q; TC6Q; TC8Q	0.160	4.1	Stainless Steel
2PK-73505	63690	1	TC14; MC3	0.170	4.3	Copper; Aluminum; Brass; Steel Tubing
2PK-73515	63691	1	TC14	0.170	4.3	Stainless Steel Only
<b>FOR TUBING CUTTERS - PLASTIC</b>						
△ 2PK-TC56QPP-R	64159	1	TC5Q; TC6Q; TC8Q	0.744	18.9	PP-R including Aquatherm®; CPVC
2PK-OP2	64180	1	TC1Q; TC1.6Q; TC2Q; T10; T15; T20	0.255	6.5	ABS; PE; PEX; PP; PEX/AL/PEX
△ 2PK-1-2PVC	64184	1	TC1Q; TC1.6Q; TC2Q; T10; T15; T20	0.255	6.5	ABS; PVC; CPVC; PVDF
△ 2PK-R5272	64186	1	TC6Q; TC8Q	0.295	7.5	PVC; ABS-Standard Wall
2PK-30-40P	64190	1	TC3Q; TC4Q; TC5Q; TC6Q	0.343	8.7	ABS; PE; PP
△ 2PK-680PVC	64192	1	TC6Q; TC8Q	0.575	14.6	PVC-Standard & Heavy Wall; CPVC
△ 2PK-3-6PVC	64194	1	TC3Q; TC4Q; TC5Q; TC6Q	0.377	9.6	ABS, PVC, CPVC - Standard Wall & 4" Heavy Wall
2PK-6QP	64198	1	TC3Q; TC4Q; TC5Q; TC6Q; TC8Q	0.555	14.0	Thick Wall PE
2PK-80P	64199	1	TC6Q; TC8Q	0.750	19.1	ABS; PE; PP
<b>FOR PIPE CUTTERS - METAL</b>						
2PK-R1032/S	63532	1	5301PD; 540ITMSO	0.450	11.4	Steel; Stainless Steel up to Schd 80
2PK-2RBS	63612	1	2-1; 2-1Q; 2-4WG; 2-3; 2-3Q; 2-4; 540ITMSO; 5301PD	0.300	7.6	Steel; Stainless Steel
2PK-2RBHD	63613	1	2-1; 2-1Q; 2-4WG; 2-3; 2-3Q; 2-4; 540ITMSO; 5301PD	0.296	7.5	HD for Steel; Stainless Steel
2PK-3RG	63616	1	4-1; 4-3; 4-4; 4-4WG	0.399	10.1	Steel; Stainless Steel
2PK-3RGCI	63617	1	4-1; 4-3; 4-4; 4-4WG	0.285	7.2	Cast Iron; Ductile Iron
2PK-2RBCI	63624	1	2-1; 2-3; 2-4; 2-4WG; H21/2	0.154	3.9	Cast Iron; Ductile Iron

## REED Replacement Cutter Wheels

Catalog No.	Item Code	Standard Pack	REED Cutter	Blade Exposure		Application
				in	mm	
<b>FOR TUBING CUTTERS - METAL</b>						
TCKCW	03376	12	TC3SL; TC5075SLR; TCK50SLR; TCK75SLR; TC1SLR; TC50SL; TC75SL; TC1SL; TC50SLR; TC75SLR; TC1SLR	0.101	2.6	Copper; CTS; CPVC
OSS	03655	12	TC1Q; TC1.6Q; TC2Q; T10; T15; T20	0.160	4.1	Stainless Steel
OCSST-2	03659	12	TC1.6Q; TC1.6RGT; TC2Q; TC2QRGT	0.281	7.1	CSST Tubing
O	03660	12	TC1Q; TC1.6Q; TC2Q; T10; T15; T20; RT15T1; RT15T2; RT15T3; RTC1.1; RTC1.4	0.180	4.6	Copper; Aluminum; Brass; Steel Tubing
32633	03661	12	MC1	0.127	3.2	Copper; Aluminum; Brass; Steel Tubing
75015	03662	12	TC11; TC17	0.125	3.2	Copper; Aluminum; Brass; Steel Tubing
75046	03663	12	TC11; TC17	0.125	3.2	Stainless Steel
30-40	03665	12	TC3Q; TC4Q; TC5Q; TC6Q; TC8Q	0.250	6.4	Copper; Aluminum; Brass; Steel Tubing
345T	03666	12	MC2	0.146	3.7	Copper; Aluminum; Brass
R4546	03668	12	MC2	0.161	4.1	Steel; Stainless Steel
R2558	03670	12	TC3Q; TC4Q; TC5Q; TC6Q; TC8Q	0.188	4.8	Muffler Systems Tubing
30-40SS	03671	12	TC3Q; TC4Q; TC5Q; TC6Q; TC8Q	0.250	6.4	Stainless Steel Tubing
73505	03690	12	TC14; TC166; MC3	0.170	4.3	Copper; Aluminum; Brass; Steel Tubing
73515	03691	12	TC14; TC166	0.170	4.3	Stainless Steel Only

# REED Replacement Cutter Wheels

Catalog No.	Item Code	Standard Pack	REED Cutter	Blade Exposure		Application
				in	mm	
<b>FOR TUBING CUTTERS - PLASTIC</b>						
△ TC56QPP-R	04159	12	TC5Q; TC6Q; TC8Q	0.744	18.9	PP-R including Aquatherm®; CPVC
OP2	04180	12	TC1Q; TC1.6Q; TC2Q; T10; T15; T20	0.255	6.5	ABS; PE; PEX; PP; PEX/AL/PEX
△ 1-2PVC	04184	12	TC1Q; TC1.6Q; TC2Q; T10; T15; T20	0.255	6.5	ABS; PVC; CPVC; PVDF
30-40P	04190	12	TC3Q; TC4Q; TC5Q; TC6Q	0.343	8.7	ABS; PE; PP
△ 680PVC	04192	12	TC6Q; TC8Q	0.575	14.6	PVC-Standard & Heavy Wall; CPVC
△ 3-6PVC	04194	12	TC3Q; TC4Q; TC5Q; TC6Q	0.377	9.6	ABS, PVC, CPVC - Standard Wall & 4" Heavy Wall
6QP	04198	12	TC3Q; TC4Q; TC5Q; TC6Q; TC8Q	0.550	14.0	Thick Wall PE
80P	04199	12	TC6Q; TC8Q	0.750	19.1	ABS; PE; PP
<b>FOR PIPE CUTTERS</b>						
R1032/S	03532	12	5301PD; 5401TMSO	0.450	11.4	Steel; Stainless Steel to Schd 80
2RBS	03612	12	2-1; 2-4WG; 2-3; 2-4; 5301PD; 5401TMSO	0.300	7.6	Steel; Stainless Steel
2RBHD	03613	12	2-1; 2-4WG; 2-3; 2-4; 5301PD; 5401TMSO	0.296	7.5	HD for Steel; Stainless Steel
2RBCI	03624	12	2-1; 2-4WG; 2-3; 2-4	0.154	3.9	Cast Iron
3RG	03616	4	4-1; 4-3; 4-4; 4-4WG	0.399	10.1	Steel; Stainless Steel
3RGCI	03617	4	4-1; 4-3; 4-4; 4-4WG	0.285	7.2	Cast Iron; Ductile Iron
<b>FOR HINGED PIPE CUTTERS</b>						
HS21/2	03502	4	H21/2	0.312	7.9	Steel; Stainless Steel; Copper
HS4	03504	4	H4; LCRC4	0.320	8.1	Steel; Stainless Steel
HS14	03505	4	H4	0.275	7.0	Steel; Stainless Steel; Cast Iron; Ductile Iron
HS6	03506	4	H6	0.390	9.9	Steel; Stainless Steel; Copper
HS16-8	03507	4	H6; H8	0.350	8.9	Steel; Stainless Steel; Cast Iron; Ductile Iron
HS8-12	03508	4	H8; H12	0.450	11.4	Steel; Stainless Steel
HX21/2	03510	4	H21/2	0.383	9.7	Steel; Stainless Steel; Schd 80
HX4	03512	4	H4; LCRC4	0.383	9.7	Steel; Stainless Steel; Schd 80
HX6	03514	4	H6	0.476	12.1	Steel; Stainless Steel; Schd 80
HX8	03516	4	H8; H12	0.567	14.4	Steel; Stainless Steel; Schd 80
HXX8	03518	4	H8; H12	0.682	17.3	Steel; Stainless Steel; Schd 100
HI4	03522	4	H4; LCRC4	0.258	6.6	Cast Iron; Ductile Iron
HI6	03524	4	H6; H8; H12	0.410	10.4	Cast Iron; Ductile Iron
H6PSE5	03525	4	H6; H8; H12	0.400	10.2	Steel; Cast Iron; Ductile Iron
2RBCI	03624	12	H21/2	0.154	3.9	Cast Iron
<b>FOR ROTARY PIPE CUTTERS</b>						
RCS8-36	03530	4	LCRC8; LCRC12; LCRC16; RC20; RC24; RC30; RC36; RC42	0.635	16.1	Steel; Stainless Steel
RC18-30	03535	4	LCRC8; LCRC12; LCRC16; RC20; RC24; RC30; RC36; RC42	0.500	12.7	Cast Iron; Ductile Iron (manual)
RCX*	03550	4	LCRC8; LCRC12; LCRC16; RC20; RC24; RC30; RC36; RC42	0.800	20.3	Heavy Wall Steel; Stainless Steel

\*Requires: one set (8) of RC8-30XR rollers (93222) when using RCX wheels.

## REED Replacement Cutter Wheels by Manufacturer

Manufacturer Cutter No.	Mfr. Wheel	REED Catalog No.	REED Item Code	Std. Pack	Blade Exposure		Application
					in	mm	
<b>GASTITE®</b>							
RT15T1; RT15T3; RT15T2; T15T1; T15T2		○	03660	12	0.180	4.6	Copper; Aluminum; Brass; Steel Tubing; CSST
<b>IMPERIAL EASTMAN®</b>							
127-F/FA/FB; TC1050; 227-FA	S32633	32633	03661	12	0.127	3.2	Copper; Aluminum; Brass
TC1000; TC1020; 374; 312-FC/FB; 274-FC/FB; 174-F	S75015	75015	03662	12	0.125	3.2	Copper; Aluminum; Brass; Steel Tubing
TC1000; TC1020; 374; 312-FC/FB; 274-FC/FB; 174-F	S75046	75046	03663	12	0.125	3.2	Stainless Steel
<b>LENOX®</b>							
21010TC118; 21011TC138; 21012TC134	21017TCW158C	○	03660	12	0.180	4.6	Copper; Aluminum; Brass; Steel Tubing
21010TC118; 21012TC134; 21011TC138; 21013TC258	21015TCW158SS	○SS	03655	12	0.160	4.1	Brass; Stainless Steel
21013TC258	21016TCW158P	1-2PVC	04184	12	0.255	6.5	PVC; Plastic
<b>SWAGELOK®</b>							
MS-TC-308	MS-TCW-308	○SS	03655	12	0.160	4.1	Stainless Steel

# REED Replacement Cutter Wheels by Manufacturer

Manufacturer Cutter No.	Mfr. Wheel	REED Catalog No.	REED Item Code	Std. Pack	Blade Exposure		Application
					in	mm	
<b>RIDGID®</b>							
50	M-50	R2558	03670	12	0.188	4.8	Muffler Systems Tubing
10; 15; 20	E-1240	OSS	03655	12	0.160	4.1	Stainless Steel
10; 15; 20	E-1240	O	03660	12	0.180	4.6	Steel
10; 15; 20	F-158	O	03660	12	0.180	4.6	Copper; Aluminum
101; 103; 104; 105; 118; 150; 150L; 131; 132; 151; 152; 153; 205 Brass	E-3469	345T	03666	12	0.146	3.7	Copper; Aluminum;
105; 150; 150L; 131; 132; 151; 152; 153; 205	E-4546	R4546	03668	12	0.161	4.1	Steel; Stainless Steel
131P; 132P; 151P; 152P; 153P; 205P	E-5272	R5272	04186	12	0.295	7.5	PVC; ABS-Standard Wall
134P; 136P; 154P; 156P	E-702	680PVC	04192	12	0.575	14.6	PVC- Standard & Heavy Wall; CPVC
134P; 136P; 154P; 156P	E-2157	6QP	04198	12	0.550	14.0	Thick Wall PE
136P; 156P	E-2880	80P	04199	12	0.750	19.1	ABS; PE; PP
1A; 2A; 42A; 202; 300; 360; 820; 364; 732; 300; 535	E-1032S	R1032/S	03532	12	0.450	11.4	Steel; Stainless Steel up to Schd 80
1A; 2A; 42A; 202; 360; 820; 364; 732	F-514	2RBS	03612	12	0.300	7.6	Steel; Stainless Steel: Galvanized Steel
1A; 2A; 42A; 202; 360; 820; 364; 732	F-3	2RBHD	03613	12	0.296	7.5	HD for Steel; Stainless Steel: Galvanized Steel
1A; 2A; 42A; 202; 360; 820; 364; 733	F-3S	2RBHD	03613	12	0.296	7.5	HD for Steel; Stainless Steel: Galvanized Steel
1A; 2A; 42A; 206; 360; 820; 364; 732	F-119	2RBCI	03624	12	0.154	3.9	Cast Iron
30; 40; 106; 108; 109; 133; 134; 136; 154; 156	E-2191	30-40	03665	12	0.250	6.4	Copper; Aluminum; Brass; Steel Tubing
30; 40; 106; 108; 109; 133; 134; 136; 154; 156	E-2558	30-40	03665	12	0.250	6.4	Copper; Aluminum; Brass; Steel Tubing
30; 40; 106; 108; 109; 133; 134; 154; 136; 156	E-2558	R2558	03670	12	0.188	4.8	Muffler Systems Tubing
30P; 40P; 106; 108; 109P; 133P; 134P; 136P; 154P; 156P	E-5299	3-6PVC	04194	12	0.377	9.6	ABS, PVC, CPVC - Standard & 4" Heavy Wall
30P; 40P; 106; 108; 109P; 133P; 134P; 154P; 136P; 156P	E-5299	30-40P	04190	12	0.343	8.7	ABS; PE; PP
30P; 40P; 133P; 134P; 136P; 154P; 156P	E-2156	30-40P	04190	12	0.343	8.7	ABS; PE; PP
3S; 4S; 44S; 466S; 466C; 466HWS; 468C; 468S; 468HWS; 472C; 472S; 472HWS; 764 Steel	F-229	3RG	03616	4	0.399	10.1	Steel; Stainless
3S; 4S; 44S; 466S; 466C; 466HWS; 468C; 468S; 468HWS; 472C; 472S; 472HWS; 764 Steel	F-229S	3RG	03616	4	0.399	10.1	Steel; Stainless
3S; 4S; 44S; 466S; 466C; 466HWS; 468C; 468S; 468HWS; 472C; 472S; 472HWS; 764	F-515	3RG	03616	4	0.399	10.1	Steel; Stainless Steel
42A; 202; 360; 820; 364; 732	E-1032	R1032/S	03532	12	0.450	11.4	Steel; Stainless Steel up to Schd 80
466; 468; 472; 1224	E-1962	3RGCI	03617	4	0.285	7.2	Cast Iron; Ductile Iron
466C; 466S; 466HWS; 468C; 468S; 468HWS; 472C; 472S; 472HWS	E-3186	R3186	03526	4	0.680	17.3	Steel; Ductile Iron Heavy Wall
<b>ARMSTRONG®</b>							
1T; 2T; 2TA		2RBS	03612	12	0.300	7.6	Steel; Stainless Steel: Galvanized Steel
1T; 2T; 2TA		2RBHD	03613	12	0.296	7.5	HD for Steel; Stainless Steel; Galvanized Steel
4A		3RG	03616	4	0.399	10.1	Steel; Stainless Steel
4A		3RGCI	03617	4	0.285	7.2	Cast Iron; Ductile Iron
<b>WHEELER-REX®</b>							
95041	8050	HS4	03504	4	0.320	8.1	Steel; Stainless Steel
95041	8078	HS4	03504	4	0.320	8.1	Steel; Stainless Steel
95061	8052	HS6	03506	4	0.390	9.9	Steel; Stainless Steel
95081; 95121	8054	HS8-12	03508	4	0.450	11.4	Steel; Stainless Steel
	8002	HX21/2	03510	4	0.383	9.7	Steel; Stainless Steel; Schd 80
95041	8051	HI4	03522	4	0.258	6.6	Cast Iron; Ductile Iron
95061; 95081; 95121	8053	HI6	03524	4	0.410	10.4	Cast Iron; Ductile Iron
95061; 95081; 95121	8076	H6PSE5	03525	4	0.400	10.2	Steel; Cast Iron; Ductile Iron
	8839	RCS8-36	03530	4	0.635	16.1	Steel; Stainless Steel
	8838	RCI8-30	03535	4	0.500	12.7	Cast Iron; Ductile Iron
9590	8001	2RBHD	03613	12	0.296	7.5	HD for Steel; Stainless Steel: Galvanized Steel
2690; 4690	8004	3RG	03616	4	0.399	10.1	Steel; Stainless Steel
9290; 9291	8012	OSS	03655	12	0.160	4.1	Stainless Steel
9290; 9291	8015	O	03660	12	0.180	4.6	Copper; Aluminum; Brass; Steel Tubing
	8021	30-40	03665	12	0.250	6.4	Copper; Aluminum; Brass; Steel Tubing
9490	8025	30-40	03665	12	0.250	6.4	Copper; Aluminum; Brass; Steel Tubing
	8034	345T	03666	12	0.146	3.7	Copper; Aluminum; Brass
	8045	R4546	03668	12	0.161	4.1	Steel; Stainless Steel
90735; 90728; 90750	8071	73505	03690	12	0.170	4.3	Copper; Aluminum; Brass; Steel Tubing
	8065	OP2	04180	12	0.255	6.5	ABS; PE; PEX; PP; PEX/AL/PEX
	8036	30-40P	04190	12	0.343	8.7	ABS; PE; PP
	8037	3-6PVC	04194	12	0.377	9.6	ABS, PVC, CPVC - Standard Wall & 4" Heavy Wall

# LARGE DIAMETER PIPE TOOLS

REED tools meet and exceed the demands of the toughest projects — and are made to last for years. These tools provide unique solutions and save the contractor money on the job. Maximum capacities are shown here. For more detailed information on any of these heavy-duty, specialized tools, turn to the catalog page numbers listed.



## Guillotine Pipe Cutters

12" (350 mm)  
p. 39

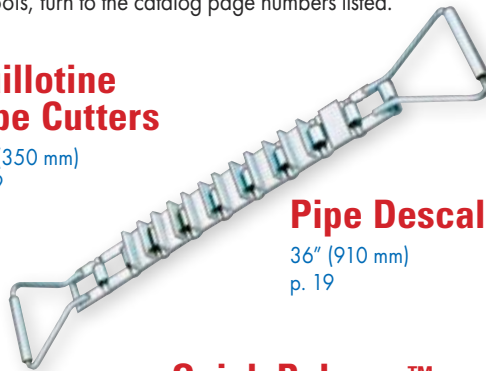

## Pipe Descalers

36" (910 mm)  
p. 19



## PE Pipe Peeler

12" (324 mm)  
p. 34

## Quick Release™ Tubing Cutters

10" (254 mm)  
p. 9 & 27



## Saw It®

24" (610 mm)  
p. 16



## Chain Wrenches

18" (457 mm)  
p. 74



## Thru-Bolt™ Larger Ratchet Wrench & Sockets

17" (432 mm) Handle & 1 5/8" Socket  
p. 78

## PLAS In-Line Rotary Pipe Cutters

28" (800 mm)  
p. 40



## Soil Pipe Cutters

15" (403 mm)  
p. 13



## Strap Wrenches

18" (457 mm)  
p. 75



## Universal Pipe Cutters

48" (1300 mm)  
p. 14 & 39



For PE



For Steel, Ductile  
or Cast Iron

## Chain Vises

12" (335 mm)  
p. 70



Manual

## PE Squeeze Tools

8" (225 mm) p. 36 - 38

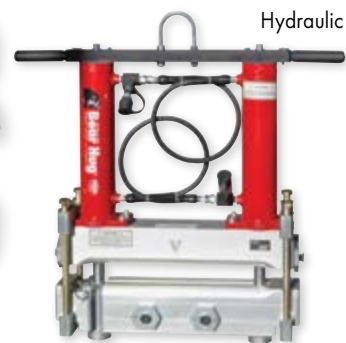

Hydraulic

## Hinged Pipe Cutters

12" (356 mm)  
p. 17

## Field Pipe Vise

20" (500 mm)  
p. 71



## Bevel Boss® Cordless Pipe Bevelers

12" (350 mm) Gasketed  
30" (762 mm) Solvent Cement Joints  
p. 33



## Yoke Pipe Vises

12" (335 mm)  
p. 71



## Rotary Pipe Cutters

42" (1067 mm)  
p. 18



RIDE Colombia

## SECTION 2

# PLASTIC PIPE TOOLS

Quick Release™ Tubing Cutters  
Scissor Shears  
Ratchet Shears  
Plastic Pipe Saws  
Internal Pipe Cutters  
Plastic Pipe Joint Kits  
Deburr/Chamfer Tools  
Clean Ream Extreme® Fitting Reamers  
Clean Ream Plus® Fitting Reamers  
Bevel Boss® Cordless Pipe Bevelers  
Pipe Bevelers  
Chamfer Tools, Drill Powered  
PEX Crimpers  
PE Pipe Peeler  
True Peel® PE Prep Tools  
Static Grounding Devices  
PE Squeeze Tools  
Bear Hug™ PE Squeeze Tool - Heavy-Duty  
Guillotine Pipe Cutters  
Universal Pipe Cutters for PE  
PLAS In-Line Rotary Pipe Cutters  
Plastic Pipe Joiners



# Quick Release™ Tubing Cutters for Plastic

## FEATURES

- Features include Quick Release™, quick advance, and manual advance, along with the ball detent wheel pin.
- Quick Release™ trigger on sliding bar zips open for quick cutter removal.
- With a simple wheel change, Quick Release™ cutters can be used for a variety of plastic pipe including PVC, CPVC, PE, PP and ABS.
- Cutter design yields best tracking and smooth operation.

Catalog No.	Item Code	Pipe Capacity		Cutter Wheel	Application	Length		Weight	
		in-nom.	actual O.D. mm			in	mm	lbs	kg
TC1QP	04110	1/8 - 1 5/16	3 - 33	OP2	ABS, PE, PEX, PP, HDPE	6	152	0.6	0.3
△ TC1QPVC	04114	1/8 - 1 5/16	3 - 33	1-2 PVC	ABS, CPVC, PVC Sch. 40	6	152	0.6	0.3
TC1.6QP	04116	1/4 - 1 5/8	6 - 42	OP2	ABS, PE, PEX, PP, HDPE	6.5	165	0.95	0.4
△ TC1.6QPVC	04118	1/4 - 1 5/8	6 - 42	1-2 PVC	ABS, CPVC, PVC Sch. 40	6.5	165	0.95	0.4
TC2QP	04120	1/4 - 2 5/8	6 - 67	OP2	ABS, PE, PEX, PP, HDPE	8	203	1.95	0.9
△ TC2QPVC	04124	1/4 - 2 5/8	6 - 67	1-2 PVC	ABS, CPVC, PVC Sch. 40	8	203	1.95	0.9
TC3QP	04130	3/8 - 3 1/2	10 - 90	30-40P	ABS, PE, PP, HDPE	11	279	2.5	1.1
△ TC3QPVC	04134	3/8 - 3 1/2	10 - 90	3-6 PVC	ABS, CPVC, PVC Sch. 40	11	279	2.5	1.1
TC3Q6QP	04138	3/8 - 3 1/2	10 - 90	6QP	PE 0.55 Thick (14 mm), HDPE	11	279	2.5	1.1
TC4QP	04140	1 7/8 - 4 1/2	48 - 114	30-40P	ABS, PE, PP, HDPE	12	305	2.8	1.3
△ TC4QPVC	04144	1 7/8 - 4 1/2	48 - 114	3-6 PVC	ABS, CPVC, PVC Sch. 40	12	305	2.8	1.3
TC4Q6QP	04148	1 7/8 - 4 1/2	48 - 114	6QP	PE 0.55 Thick (14 mm), HDPE	12	305	2.8	1.3
TC5QP	04150	2 1/2 - 5	63 - 125	30-40P	ABS, PE, PP, HDPE	13	330	3.0	1.4
△ TC5QPPR	04153	2 1/2 - 5	63 - 125	TC56QPP-R	PP-R; CPVC	13	330	3.0	1.4
TC5Q6QP	04152	2 1/2 - 5	63 - 125	6QP	PE 0.55 Thick (14 mm)	13	330	3.0	1.4
△ TC5QPVC	04154	2 1/2 - 5	63 - 125	3-6 PVC	PVC C900 & C905	13	330	3.0	1.4
TC6QP	04160	4 - 6 5/8	102 - 168	30-40P	ABS, PE, PP, HDPE	15	381	3.9	1.8
△ TC6QPVC	04164	4 - 6 5/8	102 - 168	3-6 PVC	ABS, PVC Sch. 40	15	381	3.9	1.8
△ TC6Q680PVC	04125	4 - 6 5/8	102 - 168	680PVC	PVC Heavy Wall, PVC Sch. 80, PP	15	381	3.9	1.8
TC6Q6QP	04168	4 - 6 5/8	102 - 168	6QP	PE 0.55 Thick (14 mm), HDPE	15	381	3.9	1.8
TC6Q80P	04123	4 - 6 5/8	102 - 168	80P	ABS; HDPE; PE up to 0.75" Thick (19 mm)	15	381	3.9	1.8
TC8QP*	04170	6 1/4 - 10	159 - 254	80P	ABS, HDPE, PE 0.75 Thick (19 mm)	26	660	8.0	3.6
TC8QPL	04171	6 1/4 - 10	159 - 254	80P	ABS, PE 0.75 Thick (19 mm), HDPE	26	660	8.0	3.6

\*TC8QP comes with a cradle and parting blade for cutting thick PVC.  
The parting blade can cut to a depth of 1.5 inches on any plastic pipe material (PE, PVC, ABS, etc.).  
Quick Release™ Tubing Cutters for Metal - p. 9



## WHY REED?

Quick Release™ tubing cutters were invented by REED and cover capacities up to 10" (254 mm). First used by REED, the ball detent wheel pin makes cutter wheel change easy. REED has the best cutter wheels specifically designed for all plastic applications.

VIDEO TRAINING



CUTTER WHEELS  
p. 20 - 23

# Scissor Shears

## FEATURES

- Ideal for cutting thin wall and small diameter plastic pipe or tubing, along with rubber or nylon tubing.
- Feature a handle grip design for more secure hold.
- Includes an industrial-grade, non-stick blade.
- For safety and ease of operation, use Scissor Shears with blade on bottom.

Catalog No.	Item Code	Capacity		Length		Weight	
		in-nom.	actual O.D. mm	in	mm	lbs	kg
△ SC1	04174	1.3	32	8.25	210	0.3	0.1
△ SC125	04178	1.7	42	8.5	216	0.3	0.1

## REPLACEMENT BLADES

Catalog No.	Item Code	Description
△ SC125B	94169	Non-stick Blade fits SC125, SC125SL
△ SC1B	94170	Non-stick Blade fits SC1, SC1SS, SC1SL

Scissor Shears are NOT recommended to cut PVC or CPVC for solvent cement weld connections.





PIPE TOOLS & VISES  
SINCE 1896



### WHY REED?

Broader base and 7-step ratcheting mechanism on RS1/RS1PLT models mean square cuts are easily attained with minimal clearance.

## Ratchet Shears

### FEATURES

- Ideal for cutting PE, PEX, PP and ABS pipe, plus PVC irrigation lines.
- Smoothest ratchet action for easiest cuts.
- Replace or resharpen blades for longer tool life and faster cuts.

Catalog No.	Item Code	Capacity		Length		Weight	
		in-nom.	actual O.D. mm	in	mm	lbs	kg
△ RS1PLT*	04175	1 1/4" nom. IPS (1.66" actual O.D.)	42	8.3	210	0.8	0.4
RS1	04176	1 1/4" nom. IPS (1.66" actual O.D.)	42	8.3	210	0.8	0.4
△ RS2	04177	2" nom. IPS (2.4" actual O.D.)	63	17.0	440	2.8	1.3
△ RS7290	04182	2" nom. IPS (2.4" actual O.D.)	63	13.25	337	2.4	1.1
△ RSP1	04276	1 1/4" nom. IPS (1.66" actual O.D.)	42	8.75	222	0.9	0.4
△ RSP2	04277	2" nom. IPS (2.5" actual O.D.)	63	11.5	292	1.56	0.7

\*EXCLUSIVE FEATURE: Plated blade

### REPLACEMENT BLADES

Catalog No.	Item Code	Description
RS1B	94175	RS1 Blade, RS1C Blade
△ RS2B	94176	RS2 Blade, RS2C Blade
△ RS1BPLT	94180	RS1PLT Plated Blade
△ RSP1B	94276	RSP1 Blade
△ RS7290B	94555	Blade fits REED RS7290 and Wheeler-Rex® 7290
△ RSP2B	94277	RSP2 Blade

Ratchet Shears are NOT RECOMMENDED to cut PVC or CPVC for high pressure lines or high efficiency vent lines. Instead use REED Quick Release™ Tubing Cutters on p. 27.

## Plastic Pipe Saws

### FEATURES

- Cuts ABS, CPVC, and PVC including C900.
- PPS20 and PPS24 feature 11 teeth per inch and a unique pattern create a bite that does not chatter on plastic or wood in the push or pull of the saw blade.
- Ergonomic-designed handle on PPS20 and PPS24 with large radius contours for hand comfort.
- Die cast design of handle on PPS 12 and PPS 18 makes blade change fast and easy.



Catalog No.	Item Code	Capacity		Cutting Edge Length		Length		Weight	
		in-nom.	actual O.D. mm	in	mm	in	mm	lbs	kg
PPS12	04512	3	75	11	279	17	432	0.6	0.3
PPS18	04510	4	100	16.25	413	22	559	0.7	0.3
PPS20	04720	6	150	19.5	495	23	584	1	0.5
PPS24	04724	8	200	23	584	27	686	1.1	0.5

### REPLACEMENT BLADES

Catalog No.	Item Code	Description	Cutting Edge Length		Blade Length	
			in	mm	in	mm
PPS12B	94512	PPS12 Blade	11	279	13	330
PPS18B	94510	PPS18 Blade	16.25	413	18	457
PPS20B	94720	PPS20 Blade	19.5	495	20	508
PPS24B	94724	PPS24 Blade	23	584	24	610

# Internal Pipe Cutters

## FEATURES

- Conveniently cut from the inside using a standard 3/8" drill.
- Used to cut off pipes below floor level or in the ceiling in new construction, around pools, and for replacement of closet flanges.
- Exclusive, adjustable guide on IC1SL and IC3/4SL doubles as a depth gauge.
- Abrasive or saw toothed blade option.

Catalog No.	Item Code	Blade Type	Blade Diameter		Blade Cutting Depth		Shaft Size	Weight	
			in	mm	in	mm		lbs	kg
ICIA	04500	Abrasive	1.53	38.8	0.5	13	4"	0.2	0.1
ICIS	04501	Saw Tooth	1.26	32	0.38	9.6	4"	0.2	0.1
IC1SL*	04505	Saw Tooth	1.26	32	0.38	9.6	7"	0.7	0.3
IC3/4SL*	04507	Saw Tooth	0.75	19	0.13	3.18	6"	0.4	0.2

\*EXCLUSIVE FEATURE: Adjustable guide, depth gauge

## REPLACEMENT BLADES

Catalog No.	Item Code	Blade Type	Cutting Edge Length		Length		Standard Pack
			in	mm	in	mm	
ICIRA	04502	Abrasive	1.53	38.8	0.5	13	5
ICIRS	04503	Saw Tooth	1.26	32	0.38	9.6	2
IC3/4RS	04508	Saw Tooth	0.75	19	0.13	3.18	2
IC7/8RS	04509	Saw Tooth	0.875	22.2	0.19	4.83	2



**EXCLUSIVE FEATURE**

**WHY REED?**  
SL models offer exclusive, adjustable guide and depth gauge making it easier to cut from inside pipe where other tools won't go.

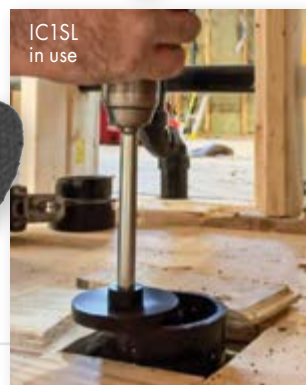

Credit: @flushinplumbing

# Plastic Pipe Joint Kits

## FEATURES

- All the tools needed for installing a perfect joint, every time.
- Cutter, deburring tool and internal cutter together in a carrying case.
- These tools work on plastic pipe such as PVC, CPVC, ABS and 636.
- Quick Release™ Tubing Cutter produces a square cut so the pipe bottoms out in the fitting for best connection.

Catalog No.	Item Code	Description	Weight	
			lbs	kg
★ <sup>Δ</sup> TC3PDEB1	04147	TC3QPVC, DEB4 & DEB1IPS-INT in a plastic case	5.6	2.5
<sup>Δ</sup> TC3-636SK	04155	TC3QPVC, DEB4 & IC1SL in a plastic case	6.9	3.1
<sup>Δ</sup> TC4-636SK	04156	TC4QPVC, DEB4 & IC1SL in a plastic case	7.1	3.2
<sup>Δ</sup> TC2PPSK	04157	TC2QPVC, DEB4 & DEB1IPS in a plastic case	5.6	2.5
<sup>Δ</sup> TC-AQRSK	04162	TC2QPVC, TC4QPVC, DEB4 & DEB1IPS in a plastic case	8.45	3.8

**NEW**





PIPE TOOLS & VISES  
SINCE 1896



Blade

DEB4

EXCLUSIVE  
TOOL

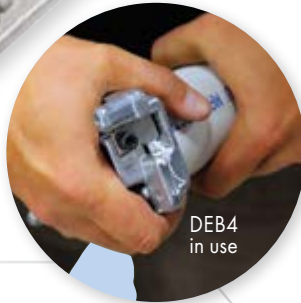

DEB4  
in use

## DEB4 Deburr/Chamfer Tool

### FEATURES

- Snap onto plastic pipe and rotate to cut an external chamfer.
- Suitable for PVC, CPVC, ABS and PP.
- Deburr and chamfer in the same rotation using DEB4.
- One tool fits six nominal pipe sizes up through 4" diameter.

Catalog No.	Item Code	Pipe Capacity	Application	Weight	
				lbs	kg
Δ DEB4	04430	1 1/4", 1 1/2", 2", 2 1/2", 3", 4" nom. 42, 50, 63, 75, 90, 114 mm O.D. actual 3/32" 15° chamfer	PVC, CPVC, ABS, PP*	0.7	0.32

\*NOT RECOMMENDED for thin wall pipe.



VIDEO  
TRAINING



## Cone Chamfer Tool Drill Powered or Manual

### FEATURES

- Efficiently chamfers the inside or outside diameter of multiple pipe sizes, including metric pipe sizes, with one tool.
- Chamfer pipe and have it ready for glue in seconds.
- Cone shape chamfers full range of plastic pipes.
- Power or manual operation possible due to removable shaft.

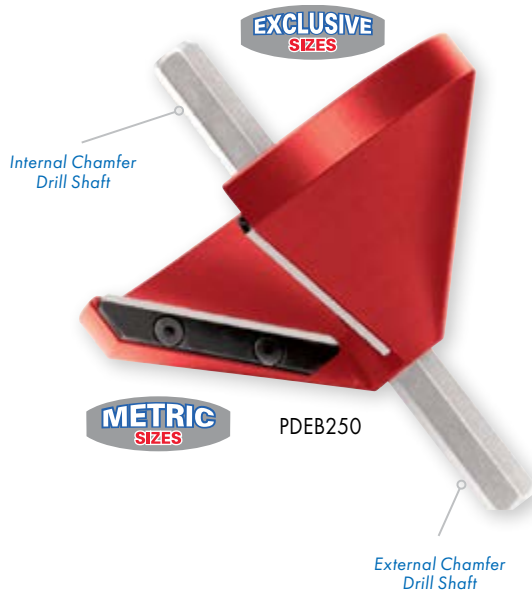

EXCLUSIVE  
SIZES

Internal Chamfer  
Drill Shaft

METRIC  
SIZES

PDEB250

External Chamfer  
Drill Shaft

Catalog No.	Item Code	Pipe Capacity				Weight	
		in-nom. O.D.	actual O.D. mm	in-nom. I.D.	actual I.D. mm	lbs	kg
PDEB250	04438	3/4 - 2 1/2	25 - 76	1 - 2 1/2	25 - 83	0.2	0.1



PDEB250 in use  
drill powered



PDEB250  
in use manual

## Cone Deburring Tool

### FEATURES

- Suitable for PVC, CPVC, ABS, PE and PP.
- For deburring inside and outside of PE, use DEB2.
- Versatile DEB2 shape suits all plastic pipe sizes up through 2" (60 mm) pipe.



DEB2

Catalog No.	Item Code	Pipe Capacity nom.	Application	Weight	
				lbs	kg
Δ DEB2	04436	up to 2" (60 mm)	PVC, CPVC, ABS, PP, PE	0.2	0.09



# DEB1 Series Deburring Tools

## FEATURES

- DEB1 offers knurled grip for slip-resistance and durable aluminum body for longevity.
- Deburr and chamfer in the same rotation.
- Suitable for PVC, CPVC, PE, ABS and PP.
- Three sizes of pipe accommodated per DEB1 tool.

Catalog No.	Item Code	Pipe Capacity nom.	Application	Pipe/Tubing	Weight	
					lbs	kg
DEB1IPS	04650	1/2", 3/4", 1" O.D.	PVC, CPVC, PE, ABS	IPS	0.4	0.2
DEB1CTS	04652	1/2", 3/4", 1" O.D.	PE, PP	CTS	0.4	0.2
DEB1-2IPS	04654	1 1/4", 1 1/2", 2" O.D.	PVC, CPVC, PE, ABS	IPS	0.9	0.4
DEB1M	04655	20, 25, 32 mm O.D.	PVC, CPVC, PE, ABS, PP	Metric	0.4	0.2
DEB1-2CTS	04656	1 1/4", 1 1/2", 2" O.D.	PE, PP	CTS	0.9	0.4
DEB1IPS-INT	04670	1/2", 3/4", 1" I.D./O.D.	PVC, CPVC, PE, ABS	IPS	0.6	0.3

DEB1IPS

One Tool  
Multiple Sizes

**PATENTED DESIGN**

DEB1CTS

DEB1IPS-INT  
in use

**METRIC SIZES**



DEB1M



I.D. End

DEB1IPS-INT  
Special design for  
inner and outer  
diameter deburring.

# DEB1 Series Deburring Tools - Drill Powered

## FEATURES

- Integrated shaft for drill power operation.
- Knurled grip for slip-resistance and durable aluminum body for longevity.
- Deburr and chamfer in the same rotation.
- Suitable for PVC, CPVC, ABS and PE pipe.
- Three sizes of pipe accommodated per tool.

**PATENTED DESIGN**

Catalog No.	Item Code	Pipe Capacity nom.	Application	Pipe/Tubing	Weight	
					lbs	kg
PDEB1IPS	04651	1/2", 3/4", 1" O.D.	PVC, CPVC, PE, ABS	IPS	0.6	0.3
PDEB1-2IPS	04657	1 1/4", 1 1/2", 2" O.D.	PVC, CPVC, PE, ABS	IPS	1.0	0.4

PDEB1-2IPS



PDEB1IPS in use

PDEB1IPS

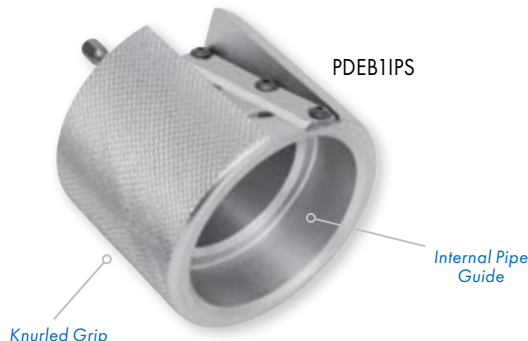

Knurled Grip

Internal Pipe Guide





PIPE TOOLS & VISES  
SINCE 1896

**XTRA  
VALUE**



PPRK4

**✓ WHY REED?**

Accurate, professional-grade Clean Ream Extreme® provide reliable clean-out of serviceable or embedded fittings to save aggravation, time and money.

**✓ GUARANTEED  
TO 1000 REAMS**



PPR200

PPR300

**✓ SPECIAL SIZE FOR  
TOILET CLOSET FLANGE**



TFR400



PPR150  
in use



## Clean Ream Extreme® Plastic Pipe Fitting Reamers

### FEATURES

- Clean leftover pipe and solvent cement residue from PVC, CPVC or ABS fittings.
- Reduce labor time and materials costs by reusing the fittings.
- Pilot diameter aids in cutting on center and stops tool at the proper cutting depth.
- Use high torque, low RPM setting on standard 1/2 inch drill to reduce heat caused by friction, to provide the cleanest ream.

Catalog No.	Item Code	Description	Shaft Size	Weight	
				lbs	kg
△ PPR75	04521	Reams 3/4" Sch. 40 PVC, CPVC & ABS Fittings	1/4" hex	0.12	0.05
△ PPR100	04522	Reams 1" Sch. 40 PVC, CPVC & ABS Fittings	1/4" hex	0.14	0.06
△ PPR125	04523	Reams 1 1/4" Sch. 40 PVC, CPVC & ABS Fittings	3/8" hex	0.3	0.13
△ PPR150	04524	Reams 1 1/2" Sch. 40 PVC, CPVC & ABS Fittings	3/8" hex	0.4	0.18
△ PPR200	04525	Reams 2" Sch. 40 PVC, CPVC & ABS Fittings	3/8" hex	0.6	0.27
△ PPR250	04532	Reams 2 1/2" Sch. 40 PVC, CPVC & ABS Fittings	3/8" hex	0.7	0.32
△ PPR300	04526	Reams 3" Sch. 40 PVC, CPVC & ABS Fittings	3/8" hex	1.2	0.52
△ PPR400	04527	Reams 4" Sch. 40 PVC, CPVC & ABS Fittings	3/8" hex	2.0	0.89
△ PPRK4	04528	Kit with PPR150, PPR200, PPR300, PPR400 in a hard plastic case	See Chart	7.6	3.5

### TOILET CLOSET FLANGE REAMER

Catalog No.	Item Code	Type	Shaft Size	Weight	
				lbs	kg
△ TFR400	04564	Removes 4" Internal Toilet Flange from 4" Sch. 40 PVC	3/8" hex	1.4	0.6

### ACCESSORIES

Catalog No.	Item Code	Type	Shaft Size	Weight	
				lbs	kg
PPR151	94528	11.5" Extension Shaft	3/8" hex	0.38	0.17

NOTE: REED plastic pipe reamers (Clean Ream Extreme® and Clean Ream Plus®) work with North America pipe diameters as they fit specific ID/OD for reaming work.

Clean Ream Extreme® and Plus® Plastic Pipe Fitting Reamers are **NOT recommended** for high pressure supply systems or for vent side of gas burning appliance piping systems.

## Clean Ream Plus® Plastic Pipe Fitting Reamers

### FEATURES

- Reliable Clean Ream Plus is engineered for 250 or more reams - far more than the competition.
- Mid-priced model gives exceptional service which means less downtime.
- Save time and materials by eliminating the need to replace entire sections of pipe.
- Designed to ream-out Schedule 40 PVC, CPVC & ABS fittings.
- Heat-treated for long life, the cutting disc may be sharpened and/or replaced.

**✓ GUARANTEED  
TO 250 REAMS**



CRP200

CRP150

**✓ WHY REED?**

Mid-price solution for a durable tool that respectfully cleans out plastic pipe fittings.

Catalog No.	Item Code	Description	Shaft Size	Weight	
				lbs	kg
CRP150	04517	Reams 1 1/2" Sch. 40 PVC, CPVC & ABS Fittings	3/8" Hex	0.3	0.1
CRP200	04518	Reams 2" Sch. 40 PVC, CPVC & ABS Fittings	3/8" Hex	0.4	0.18



# Bevel Boss® Cordless Pipe Bevelers

## FEATURES

- Portable unit uses battery power to bevel plastic pipe quickly and safely.
- Adjustable beveler creates external bevel on 2" and larger diameter plastic pipe.
- Ideal for large diameter pipe due to portability on jobsite.
- Operator safety is important and the REED system provides a secure way to cut a consistent bevel.
- Adjust bevel length on pipe by choosing the right Router Bit.
- Pipe beveler adapter heads convert popular die grinders (Bosch®, DeWalt®, Milwaukee®) to serve as plastic pipe bevelers.



CPBDK

Catalog No.	Item Code	Description	Capacity		Weight	
			in. nom	mm	lbs	kg
△ CPBDBAT	04653	Kit with Beveler Adapter, Router Bit, DeWalt® Die Grinder and Battery	2 & up	50	8.3	3.8
△ CPBDBT	04658	Base Tool with Beveler Adapter and DeWalt® Die Grinder (Battery not included)	2 & up	50	3.95	1.8
△ CPBDK	04659	Kit with Beveler Adapter, RBIT1 Router Bit, DeWalt® Die Grinder, Battery and Charger	2 & up	50	9.3	4.2
★ △ CPB2DBC	04661	Kit with Beveler Adapter, Router Bit, DeWalt® Die Grinder, 2 Batteries and Charger	2 & up	50	10.6	4.8
△ CPBDKE	04666	Kit with Beveler Adapter, RBIT1 Router Bit, DeWalt® Die Grinder - EXPORT ONLY	2 & up	50	5.5	2.5

## POWER SOURCE

Brand	Die Grinder Model	Uses Adapter Head
Bosch®	DGSH18IBL	04646
DeWalt®	DCG426B	04648
Milwaukee®	2784-22	04649
Milwaukee®	2784-20	04649
Milwaukee®	2984-20	04671
Milwaukee®	2939-20	04671



RBIT1

## BEVEL BOSS® PIPE BEVELER ADAPTER HEADS\*\*

Catalog No.	Item Code	Description	Weight	
			lbs	kg
CPBBADP	04646	Adapter Head Only, Fits Bosch® Die Grinder	1.25	0.57
CPBDADP	04648	Adapter Head Only, Fits DeWalt® Die Grinder	1.33	0.60
CPBMADP	04649	Adapter Head Only, Fits Milwaukee® Die Grinder	1.38	0.63
★ CPBMADP29	04671	Adapter Head Only, Fits Milwaukee® Die Grinder	1.38	0.63

\*\*Router bit sold separately.



CPBMADP



CPBDK in use

## ROUTER BITS AND ACCESSORIES

Catalog No.	Item Code	Description	Bevel Length	
			in.	mm
△ RBIT1	44644	Carbide Router Bit, 15°, 1/4" Shaft	1/8 - 5/8"	
△ RBIT2	44648	Carbide Router Bit, 12°, 1/4" Shaft	7/16 - 1"	
△ RBIT1M	44653	Carbide Router Bit, 15°, 8 mm Shaft	3.2 - 15.9 mm	
△ RBIT2M	44655	Carbide Router Bit, 12°, 8 mm Shaft	11.1 - 25.4 mm	
★ CPBVAC	04675	Bevel Boss® Vacuum Adapter	-	



REED Bevel Boss® allows flexibility by offering a pipe beveling solution compatible with three different die grinder brands.



VIDEO TRAINING



# Pipe Bevelers

## FEATURES

- Pipe Beveler only needs a few turns around the pipe to make the 15° smooth bevel.
- Bevels all types of plastic pipe, including gasketed PVC and C900 PVC in about 1 minute.
- Strong, reinforced aluminum frame for durability.
- Adjusts to bevel multiple sizes with one tool.

Catalog No.	Item Code	Pipe Capacity		Weight	
		in-nom.	actual O.D. mm	lbs	kg
BT1	04395	1 1/2 - 8	40 - 200	3.0	1.4
BT2	04398	1 1/2 - 12	40 - 300	6.1	2.8

Thumb Screw Adjustment



BT2 in use



BT1 in use



Much faster, safer, and far more effective than a file or power saw as it reduces the possibility of injury and leaks after joining pipe.



VIDEO TRAINING





PIPE TOOLS & VISES  
SINCE 1896

**GREAT FOR  
SYSTEM 636®  
VENT PIPE**



PB4 in use



PB3 interior



PB4



## Chamfer Tools - Drill Powered

### FEATURES

- Quickly chamfers pipe for solvent connections.
- Features strong, aluminum body and 3/8 inch hex, steel shaft.
- Uses drill power which eliminates user fatigue when making multiple cuts/chamfers.
- Deburrs inside and outside simultaneously, in just seconds.
- Produces smooth, consistent chamfer on plastic pipe, eliminating leaky glue joints that can be caused by improper chamfer.

Catalog No.	Item Code	Description	Pipe Capacity		Weight	
			in-nom.	actual O.D. mm	lbs	kg
PBKIT	04660	Kit with 2", 3" and 4" tools with case	-	-	6.6	3.0
PB2	04662	for 2" plastic pipe	2	52.2 ID / 60.3 OD actual	0.4	0.2
PB3	04663	for 3" plastic pipe	3	77.9 ID / 88.9 OD actual	0.5	0.2
PB4	04664	for 4" plastic pipe	4	102.2 ID / 114.3 OD actual	0.7	0.3

## PEX Crimpers

### FEATURES

- REED tool crimps rings easily, giving good connections.
- PEX Crimper are the right tools for PEX systems and properly seal the rings without distortion.
- Each REED copper ring crimper includes a go/no-go gauge and an Allen wrench.



PXCR1234M

PEXOH12

Catalog No.	Item Code	Description	Weight	
			lbs	kg
△ PXCR12S	04900	1/2" capacity with 8 3/4" handle	3.0	1.4
△ PXCR34S	04903	3/4" capacity with 9" handle	3.0	1.4
△ PXCR1M	04904	1" capacity with 11 1/2" handle	4.0	1.8
△ PXCR1234M	04910	1/2" - 3/4" capacity with 11 1/2" handle	4.3	1.9
△ PEXOH12	04920	1/2" capacity, one hand style	2.5	1.1
△ PEXOH34	04925	3/4" capacity, one hand style	2.6	1.2

Handle length does not include head.

## PE Pipe Peeler

### FEATURES

- One tool does a range of pipe.
- Creates a uniformly peeled surface.
- Works well even on out-of-round pipe.
- Strong thermoplastic rollers and plated sides on chain resist corrosion.



PEPEEL12 in use



PEPEEL6

Catalog No.	Item Code	Pipe Capacity		Weight	
		in-nom.	actual O.D. mm	lbs	kg
PEPEEL6	04631	1 1/2 - 6*	48 - 168	3.1	1.4
PEPEEL12	04632	6 - 12	168 - 324	10.9	5.0

\*O.D. must be 1.9" (48.3 mm) or more



# True Peel® PE Prep Tools

## FEATURES

- Prepares the ends of PE pipe and tapping tees for electrofusion.
- Removes 0.009" - 0.12" (0.23 mm - 0.3 mm) peel thickness.
- Spring actuated blade gives a complete peel, even on out-of-round pipe.
- Observation window indicates the completion of the peel.
- Close fitting mandrel rounds pipe that may be oval.
- Hardened tool steel cutting blade with two cutting edges for twice the life.
- Includes a protective carrying case.

Catalog No.	Item Code	Description	Weight	
			lbs	kg
PEP50CTS7	04634	Fits 1/2" CTS SDR7 0.090 Wall	0.9	0.41
PEP75IPS11	04635	Fits 3/4" IPS DR11 0.095 Wall	1.2	0.54
PEPIIPS7	04624	Fits 1" IPS DR7 0.188 Wall	1.4	0.6
PEPICTS7	04627	Fits 1" CTS SDR7 0.161 Wall	1.3	0.6
PEPICTS115	04636	Fits 1" CTS SDR11.5 0.099 Wall	1.3	0.6
PEPIIPS11	04637	Fits 1" IPS DR11 0.120 Wall	1.4	0.6
PEPI25IPS10	04626	Fits 1 1/4" IPS DR10 0.166 Wall	1.9	0.9
PEPI25IPS11	04638	Fits 1 1/4" IPS DR11 0.151 Wall	1.9	0.9
PEPI25CTS11	04625	Fits 1 1/4" CTS SDR11 0.121 Wall	1.5	0.7
PEP2IPS11	04639	Fits 2" IPS DR11 0.216 Wall	3.1	1.4

## TRUE PEEL® METRIC

Catalog No.	Item Code	Description
PEP32MM	04680	Fits 32mm DR11, 3.0 mm Wall
PEP40MM	04681	Fits 40mm DR11, 3.7 mm Wall
PEP63MM	04683	Fits 63mm DR11, 5.8 mm Wall



# Static Grounding Devices

## FEATURES

- Ground the work area to increase safety for the operator.
- Static electricity grounding can dissipate the charge and minimize the possibility of ignition.
- 7 foot cable provides convenient working distance from tool to ground.
- Half inch probe diameter of PEGR7 provides strength and reduces buckling.

Catalog No.	Item Code	Description	Weight	
			lbs	kg
PEGR7*	04621	Set screw lugs, 7 ft. cable	1.3	0.6
PEGRM*	04622	Magnet connection, 7 ft. cable	0.6	0.3

\*EXCLUSIVE FEATURES: PEGR7 stocky probe diameter, PEGRM magnet connection





PIPE TOOLS & VISES  
SINCE 1896

# PE Squeeze Tools - Manual

## FEATURES

- Easy to use in line because of swing bar and no loose parts.
- Aluminum parts on PES2 and larger tools reduce tool weight for easier handling.
- Positive stops prevent damage caused by over-clamping.
- PES6 and PES8 also work for metric pipe, with the proper stops.

### ✓ WHY REED?

Automatically provides multiple pipe/SDR stops in one tool. Also, all parts store on the tool, making it self-contained.

Sliding Bar Handle

PES8M

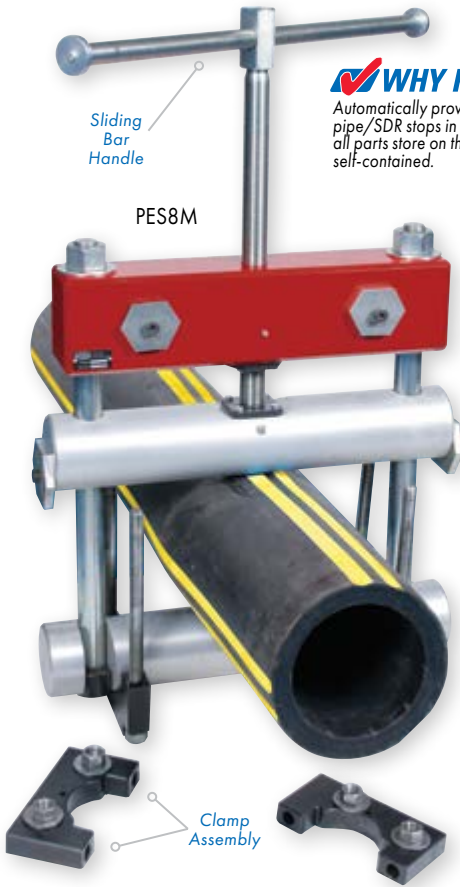

Catalog No.	Item Code	Capacity		Pipe/SDR Stop(s)	Height		Weight	
		in-nom.	Actual O.D.		in	mm	lbs	kg
△ PES8M*	04308	3 - 8	89 - 219 mm	98319 & 98320 pair of each	28	711	130	59.1
PES6M*	04313	3 - 6	89 - 168 mm	98356 & 98320 pair of each	28	711	116	52.7
PES6METRIC*	04706	-	63 - 160 mm	98355, 98360 & 98319SO pair of each	28	711	116	52.7
△ PES8MMETRIC*	04708	-	63 - 200 mm	98355, 98360 & 98319SO pair of each	28	711	130	59.1



\*Model ships freight.

PE Squeeze Tools conform to ASTM F1041 and F1563.

NOTE: It is strongly recommended to use a static grounding device with PE Squeeze Tools. Use grounding device #04621 on p. 35 as a precaution against static build-up, dissipate charge and minimize the possibility of ignition.



COMPLETE LIST OF REPLACEMENT STOPS AVAILABLE ONLINE



CTS and IPS Stops

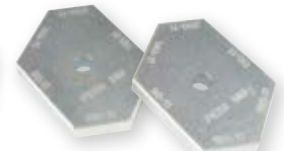

Metric Stops

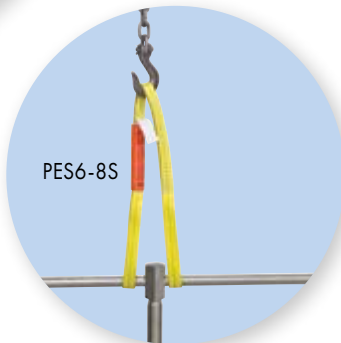

PES6-8S



PES8M in use

# PE Squeeze Tools - Small Diameter, Manual

## FEATURES

- "C" shape allows easy movement on and off pipe.
- Four-sided stop fits 3 sizes each of IPS and CTS pipe/tubing.
- Top bar is drilled and tapped for grounding screw.
- Steel construction helps its compact size pack maximum strength.



PES1IPS/CTS

Built-in Stops

Catalog No.	Item Code	Capacity		Pipe/SDR Stop(s)	Height		Weight	
		in-nom.	Actual O.D.		in	mm	lbs	kg
PES1IPS/CTS	04290	1/2 - 1	0.63" - 1.32"	94279	11	280	6.4	2.9

PE Squeeze Tools conform to ASTM F1041 and F1563.



△ WARNING: Cancer and Reproductive Harm. www.P65Warnings.ca.gov

# Double Squeeze™ PE Squeeze Tools - Manual

## FEATURES

- Optimized double bar design best manages flow control.
- Screw drive design reduces manual operator squeeze effort by approximately 30%.
- Hand placement area machined into bottom bar allows for easy lifting.
- Materials changes yield a 10% weight reduction over prior PES4 models.
- ASTM squeeze and release rates posted on tool body.

Catalog No.	Item Code	Capacity		Pipe/SDR Stop(s)	Height		Weight	
		in-nom.	Actual O.D.		in	mm	lbs	kg
★ <sup>Δ</sup> PES2IPSDB	04332	1/2 - 2	0.84" - 2.38"	98079	12	305	11.2	5.1
★ <sup>Δ</sup> PES2CTSDB	04333	1/2 - 2	0.63" - 2.13"	98078	12	305	11.2	5.1
★ <sup>Δ</sup> PES2DBM	04334	-	20 - 63 mm	98124	12	305	11.2	5.1
★ <sup>Δ</sup> PES4DB	04336	2 - 4	2.38" - 4.50"	98094	20	508	35.5	16.1
★ <sup>Δ</sup> PES4DBM	04337	-	75 - 110 mm	98121	20	508	35.5	16.1
★ PES6DB	04338	3 - 6	3.5" - 6.63"					
★ PES6DBM	04339	-	63 - 160 mm					
★ PES8DB	04340	3 - 8	3.5" - 8.63"					
★ PES8DBM	04341	-	63 - 200 mm					

**NEW** COMING SOON!



EXCLUSIVE FEATURES



## ACCESSORIES

Catalog No.	Item Code	Description
PES4CCST	98381	Color-Coded Stops with 4" SDR9
PES4CASE	98299	Tool Case
PES4STOP	98094	Standard Stops - Imperial
PES4MM	98121	Standard Stops - Metric
CTS	98078	Stops to Convert PES2IPSDB to PES2CTSDB
IPS	98079	Stops to Convert PES2CTSDB to PES2IPSDB
PES6-8S	98329	Webbed Lifting Strap (see p. 36)

PE Squeeze Tools conform to ASTM F1041 and F1563.

NOTE: It is strongly recommended to use a static grounding device with PE Squeeze Tools. Use grounding device #04621 on p. 35 as a precaution against static build-up, dissipate charge and minimize the possibility of ignition.



## WHY REED?

New design removes operator pain points with its reduced weight and durable construction, plus the specially designed, hand placement areas for lifting. To reduce user frustration, the ASTM squeeze and release rates are also adhered to the tool body, eliminating the need to find the manual.

# PE Squeeze Tools - Hydraulic, Mid-Duty

## FEATURES

- Mid-duty 8" Hydraulic PE Squeeze Tool.
- Exerts 50,000 lb. (222,400 N) of force onto the pipe.
- PES8H comes standard with a single acting manual hydraulic pump.
- Positive stops prevent pipe damage caused by over-clamping.
- Easy to use in line because bottom bar swings open to fit around pipe.

Catalog No.	Item Code	Capacity		Pipe/SDR Stop(s)	Height		Weight	
		in-nom.	Actual O.D.		in	mm	lbs	kg
<sup>Δ</sup> PES8H*	04309	3 - 8	89 - 219 mm	98319 & 98320 pair of each	28	711	233.0	105.9
<sup>Δ</sup> PES8HMETRIC*	04707	-	63 - 200 mm	98355, 98360 & 98319SO pair of each	28	711	233.0	105.9

<sup>Δ</sup> Model ships freight.  
PE Squeeze Tools conform to ASTM F1041 and F1563.

**METRIC SIZES**

NOTE: It is strongly recommended to use a static grounding device with PE Squeeze Tools. Use grounding device #04621 on p. 35 as a precaution against static build-up, dissipate charge and minimize the possibility of ignition.

## ACCESSORIES

Catalog No.	Item Code	Description
FCVPES8H	94317	Flow Control Valve for PES8H

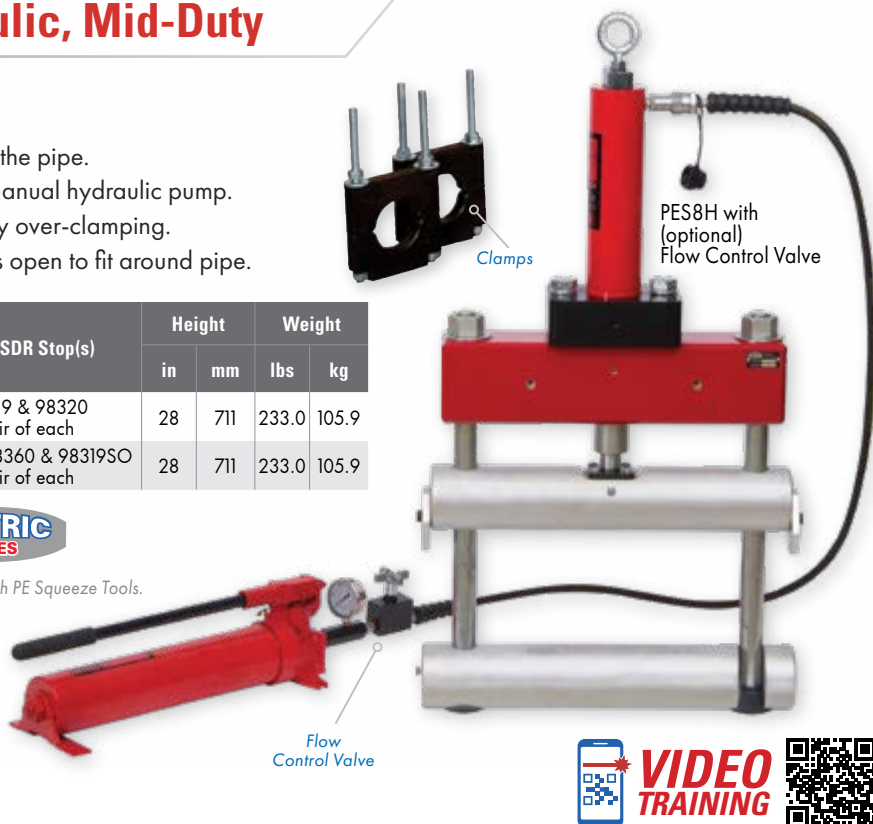



PIPE TOOLS & VISES  
SINCE 1896

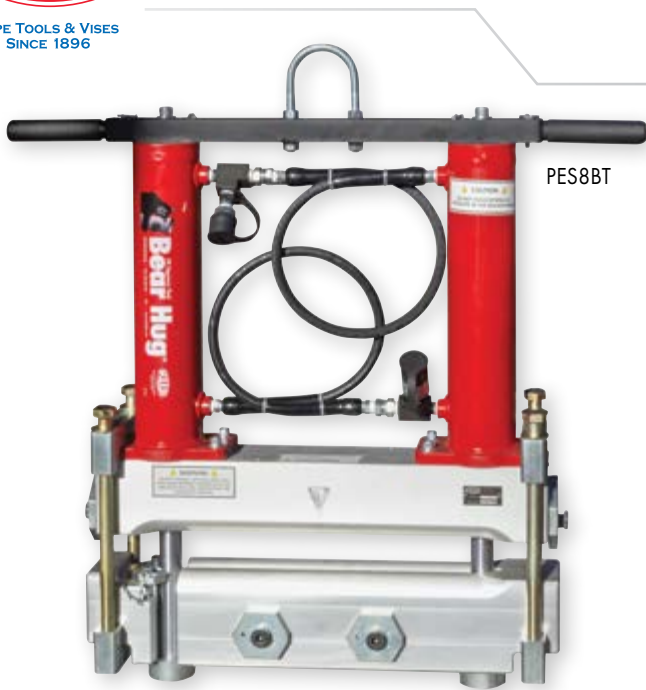

PES8BT

## Bear Hug™ PE Squeeze Tool - Hydraulic, Heavy-Duty

### FEATURES

- Modular PE squeeze tool system allows choice of manual hydraulic or air-over-hydraulic pump operation.
- Double bar design for squeeze confidence.
- Massive 83,400 lb. (371,000 N) squeeze force.
- Weight conscious REED design is almost 100 pounds (45 kg) less than competitive model.
- Includes two sets of color-coded pipe stops for North America Imperial (PES8BT) or metric (PES8BTM) pipe sizes.
- Maximize tool efficiency by using clean air through an FRL such as PESFRLA.

Catalog No.	Item Code	Capacity	Description	Height		Weight	
				in	mm	lbs	kg
△ PES8BT*	04328	3" - 8"	Base Tool for Bear Hug™	33	838	175	79.5
△ PES8BTM*	04715	90-225 mm O.D.	Metric Bear Hug™ Base Tool for Metric Pipe	33	838	175	79.5

\* Model ships freight.  
PE Squeeze Tools conform to ASTM F1041 and F1563.

NOTE: It is strongly recommended to use a static grounding device with PE Squeeze Tools. Use grounding device #04621 on p. 35 as a precaution against static build-up, dissipate charge and minimize the possibility of ignition



CHOOSE A PUMP

PESMPA

### PUMP - REQUIRED FOR TOOL OPERATION

Catalog No.	Item Code	Description	Weight	
			lbs	kg
△ PESMPA	04329	2-stage Hydraulic Hand Pump	35	15.9
△ PESAPA	04330	Air-over-Hydraulic Pump	30	13.6

### ACCESSORY

Catalog No.	Item Code	Description
PESFRLA	04331	Filter-Regulator-Lubricator
PEGR7	04621	Static Grounding Device
PES8BHLG	98390	Imperial Stops, Large
PES8BHSM	98391	Imperial Stops, Small-Medium
PESBMMM11	98392	Metric Stops - SDR 11
PESBMMM17	98393	Metric Stops - SDR 17



PESAPA

PESFRLA



PES8BT  
in use



### WHY REED?

Bear Hug™ squeeze tool is lighter and offers more force output than comparable models. Modular with a choice of pump style to fit user preferences. Also, the Bear Hug™ system features double bar squeeze points which are optimized for best flow control performance.

# Guillotine Pipe Cutters

## FEATURES

- Manual, guillotine style cutter slices smoothly through PE, including HDPE.
- All aluminum construction results in greater rigidity and lighter tool with 22%+ weight reduction versus prior HPC8 model.
- Greater pipe capacity of HPC8+, up to 9.06" O.D. fits true 8" DIPS and IPS for PE.
- Aluminum rails and crosshead have a hard anodized finish to reduce wear on sliding surfaces.
- Superior cuts with USA made blade.

Catalog No.	Item Code	Pipe Capacity		Application	Length		Weight	
		in-nom.	actual O.D. mm		in	mm	lbs	kg
▲ HPC4+	04605	1 1/2 - 4 DIPS & IPS	50 - 125	PE	18.6	472	11	4.99
▲ HPC8+	04609	3 - 8 DIPS & IPS	90 - 230	PE	29.6	752	27.4	12.4
▲ HPC12+	04612	4 - 12	114 - 350	PE	51	1295	100	45.5



\*Model ships freight.

HPC models cut PE only and will not cut PVC or PP (polypropylene)

NOTE: It is strongly recommended to use a static grounding device with Universal Pipe Cutters. Use grounding device #04621 on p. 35 as a precaution against static build-up, dissipate charge and minimize the possibility of ignition.

## REPLACEMENT BLADES

Catalog No.	Item Code	Description
▲ HPC8B	40027	HPC8 Blade
▲ HPC4B	40329	HPC4 Blade
▲ HPC12B	94903	HPC12 Blade



HPC4+  
in use



BEST EVER!

HPC8+



## WHY REED?

Due to its crosshead and blade design, all HPCs produce a straight cut with minimal blade wear. Safer to use than abrasive saws because no PE chip residue remains in the pipe that may later clog valves.

HPC12  
in use



# Universal Pipe Cutters for PE

## FEATURES

- Special blades and blade guard for cutting PE.
- Includes all the parts for successful PE cuts.

Catalog No.	Item Code	Pipe Capacity		Gross Weight	
		in-nom.	actual O.D. mm	lbs	kg
UPC836APE *	07517	8 - 36	200 - 1000	101	45.9
UPC848APE *	07518	8 - 48	200 - 1300	106	48.2



\*Model ships freight.

NOTE: It is strongly recommended to use a static grounding device with Universal Pipe Cutters. Use grounding device #04621 on p. 35 as a precaution against static build-up, dissipate charge and minimize the possibility of ignition.

Universal Pipe Cutters and Accessories - p. 14

## REPLACEMENT BLADES

Catalog No.	Item Code	Description	Pipe Diameter	
			in	mm
UPCSTEEL4	97519	Carbide-tipped 4" Blade cuts up to 2 23/32" (18.3 mm) PE wall thickness	6 - 8	150-200
UPCSTEEL6	97520	Carbide-tipped 6" Blade cuts up to 1 23/32" (43.7 mm) PE wall thickness	8 - 48	200-1300
UPCPE8	97521	8" Blade cuts up to 2 23/32" (69 mm) wall thickness	26 - 48	660-1300

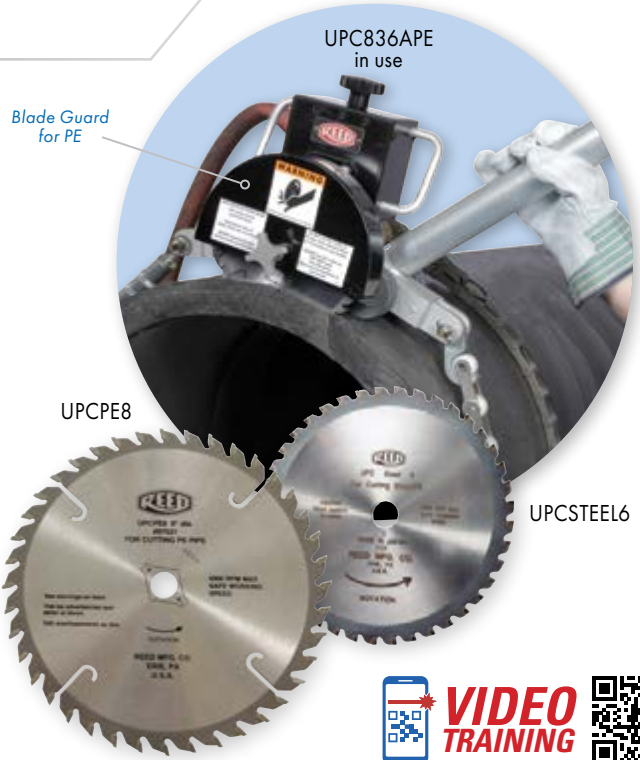

UPC836APE  
in use

Blade Guard  
for PE

UPCPE8

UPCSTEEL6



▲ WARNING: Cancer and Reproductive Harm. www.P65Warnings.ca.gov



VIDEO  
TRAINING





PIPE TOOLS & VISES  
SINCE 1896

EXCLUSIVE  
TOOL



PLAS3



Bevel  
Blade

**WHY REED?**  
Proprietary tool cuts square on  
even the largest plastic pipe:  
28" (800 mm). Cut and bevel  
in-line.



## PLAS In-Line Rotary Pipe Cutters

### FEATURES

- Safe to use as it creates no dust and chips fall where they are cut. There is no danger of chips being blown well into pipe.
- Only 6" - 8" clearance needed to turn PLAS tool around pipe.
- Cuts out-of-round pipe because of spring loaded nuts.
- With PVC models, simultaneously cut and bevel PVC using cut-off blade and bevel blade.
- Inexpensive tool for contractors to make a cut for a tie-in or pipe break and then get the line back in use. Reduce overall labor costs!

Catalog No.	Item Code	Pipe Capacity		Sections Used	Application*	Weight	
		in-nom.	actual O.D. mm			lbs	kg
△ PLAS1	04470	6 - 12	160 - 335	A, B, C	PVC SCH. 40, PVC C900 & C905, CPVC	52	23.6
△ PLAS1PE	04474	6 - 12	160 - 335	A, B, C	PE, HDPE	52	23.6
△ PLAS2	04475	14 - 18	355 - 500	B, C (2), D	PVC SCH. 40, PVC C900 & C905, CPVC	57	25.9
△ PLAS2PE	04477	14 - 18	355 - 500	B, C (2), D	PE, HDPE	57	25.9
△ PLAS3	04480	14 - 24	355 - 630	B, C (3), D	PVC SCH. 40, PVC C900 & C905, CPVC	62	28.2
△ PLAS3PE	04483	14 - 24	355 - 630	B, C (3), D	PE, HDPE	62	28.2
△ PLAS4	04485	14 - 28	355 - 800	B, C (4), D	PVC SCH. 40, PVC C900 & C905, CPVC	68	30.9
△ PLAS4PE	04487	14 - 28	355 - 800	B, C (4), D	PE, HDPE	68	30.9

## PLAS Hand-Over-Hand Rotary Pipe Cutters

### FEATURES

- Excellent for cutting PVC or PE pipe in-trench or above ground.
- Attached handles permit fast hand-turning – about half the cutting time of a regular PLAS cutter.
- Leaves a disposable remnant (not dust or chips) that is easy to recycle.
- With PVC models, simultaneously cut and bevel PVC using cut-off blade and bevel blade.
- Simple to transport and fast to use on PE and PVC.

EXCLUSIVE  
TOOL



PLASOH

Catalog No.	Item Code	Pipe Capacity		Sections Used	Application*	Weight	
		in-nom.	actual O.D. mm			lbs	kg
△ PLASOH	04463	4 - 8	106 - 240	E (2)	PVC SCH. 40, PVC C900 & C905, CPVC	21	9.6
△ PLASOHPE	04464	4 - 8	106 - 240	E (2)	PE, HDPE	21	9.6
△ PLASOH12PE	04468	4 - 12	106 - 335	E (2), B (1)	PE, HDPE	52	23.6
△ PLASOH12	04469	4 - 12	106 - 335	E (2), B (1)	PVC SCH. 40, PVC C900 & C905, CPVC	52	23.6

PLASOHPE with  
FPV20 vise

PLASOH using  
PLASPCB blade

PLASOH Hand-Over-Hand in use



**\*Specific Limitations for PE:**  
up to 14" pipe (355 mm) - 2" (51 mm) wall thickness  
up to 18" pipe (500 mm) - 1 1/2" (38 mm) wall thickness  
up to 28" pipe (800 mm) - 1" (25.4 mm) wall thickness  
Applies to ALL PLAS models

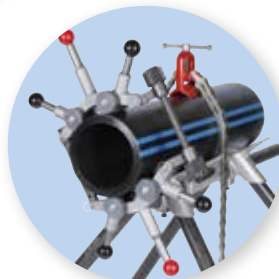



# Plastic Pipe Joiners for Solvent Cement Connections

**✓ FOR BRANCH CONNECTIONS  
PPJFA IS THE SOLUTION**

## FEATURES

- Controlled feed by user prevents over-insertion.
- Efficiently connect 4" - 12" (114 - 324 mm) PVC solvent cement joints using the PVC pipe joining tool and individually sized saddles.
- PPJFA Fitting Attachment is required for solvent cement branch connections.

Catalog No.	Item Code	Application	Pipe Capacity		Weight	
			in-nom.	actual O.D. mm	lbs	kg
PPJ	04446	Solvent Cement Connection	4 - 12	114 - 324	44.0	20.0
PPJFA	04439	Fitting Attachment for Solvent Cement Connection	4 - 12	114 - 324	39.0	17.7

## SADDLES

Catalog No.	Item Code	Pipe Capacity		Weight	
		in-nom.	actual O.D. mm	lbs	kg
PPJ4S	04442	4.5	114	4.0	1.8
PPJ6S	04444	6.6	168	4.5	2.0
PPJ8S	04447	8.8	224	6.0	2.7
PPJ10S	04448	10.8	273	7.0	3.2
PPJ12S	04449	12.8	324	7.0	3.2

## ✓ WHY REED?

All Plastic Pipe Joiner models offer an easy-to-use design for single-person operation for seals with no leaks.



**VIDEO  
TRAINING**

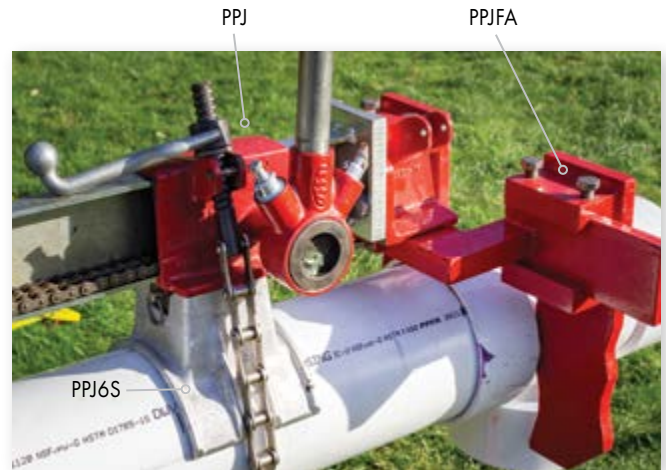
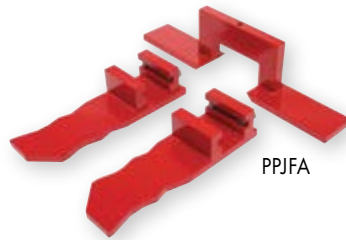

NOTE: Fitting attachment (PPJFA) and saddles sold separately from PPJ.



# Plastic Pipe Joiners for Gasketed Pipe

## FEATURES

- Controlled feed by user prevents over-insertion.
- Easily join or separate gasketed 4" - 16" (114 - 434 mm) PVC pipe using the PPJ pipe joiner tool and PPJVS universal saddles.
- Safe, portable solution for joining pipe without damage to gasket or pipe.
- Alignment system allows best control for pipe joining.

Catalog No.	Item Code	Application	Pipe Capacity		Weight	
			in-nom.	actual O.D. mm	lbs	kg
PPJ	04446	Gasketed Pipe	4 - 16	114 - 434	44.0	20.0
PPJVS	04441	Saddles for Gasketed Pipe (one pair)	4 - 16	114 - 434	8.0	3.6



**VIDEO  
TRAINING**



NOTE: PPJVS sold separately from PPJ.

## SECTION 3

# WATER SERVICES TOOLS

Feed Tap™ Drilling Machine  
Drilling Machines  
Direct Tapping Machine  
Drill Taps  
PVC/PE Drilling Machines  
Power Units for Tapping/Drilling  
Manhole Hooks  
Fiberglass Probe Rod  
Cordless Power Drive  
Valve Operators  
Utility Clutch  
Valve & Curb Keys  
Meter Box & Curb Box Lid Keys  
Corporation Stop Key Sockets  
Waterworks Level  
Flare Tools for PE Water Service Lines  
Shut-Off Tools  
Hammer Flaring Tools for Copper  
Rerounding Tools  
Round It® Straightener/Rerounder  
Pump Stick®  
Meter Pit Pump



# Feed Tap™ Drilling Machine

## FEATURES

- Match the kit to the application considering size, threads and pipe.
- Preferred tool for PVC taps using independent feed control and shell cutters for PVC and PE.
- Superior performance and life of the heavy-duty Carbide Tipped Shell Cutters.
- Coupon Retaining Pilot Drill Bit with proven technology provides reliable results for holding the coupon.
- All units are shipped in an impact-resistant, compact case.

Catalog No.	Item Code	Description	Gross Weight	
			Lbs	kg
△ FTB	09160	Feed Tap™ Base Machine	27.0	12.3
△ FT2000CC110	09161	AWWA/110 Compression Feed Tap Kit 3/4" - 2"	36.0	16.4
△ FT2000	09162	AWWA Feed Tap Kit 3/4" - 2"	33.0	15.0
△ FT2000UNIV	09165	Complete Feed Tap Kit 3/4" - 2"	39.0	17.7
△ FT2000CCNPT	09166	AWWA/110 Comp 3/4" - 1" and 1 1/2" - 2" NPT Feed Tap Kit	34.0	15.5
△ FT1000CC110	09167	AWWA/110 Comp Feed Tap Kit 3/4" - 1"	29.0	13.2
△ FTP2000UNIV	09168	Feed Tap Kit 3/4" - 2" for Plastic Pipe Only	41.0	18.6
△ FTBB	09169	Feed Tap™ Main Unit, CRPD25 and TMTC6 – no case	9.0	4.1

NOTE: Feed Tap™ is designed to be used with corporation stops and bronze gate valves up to 2". To tap through a 2" iron body gate valve, one 1" NPT female x 2" NPT male bushing is REQUIRED. Feed Tap™ not to be used on gas lines.

Mechanical Hot Tapping Machine on p. 87 is recommended for steel pipe.

## CORPORATION ADAPTERS

Catalog No.	Item Code	Description	Weight	
			Lbs	kg
FT75CC110	09170	3/4" AWWA and 110 Comp	0.60	0.27
FT100CC110	09171	1" AWWA and 110 Comp	0.55	0.25
FT150	09172	1 1/2" AWWA	1.20	0.55
FT150110	09173	1 1/2" 110 Comp	1.35	0.61
FT200	09174	2" AWWA	1.40	0.64
FT200110	09175	2" 110 Comp	1.40	0.64
FT150NPT	99109	1 1/2" NPT	0.80	0.36
FT200NPT	99112	2" NPT	0.80	0.36
FT75NPT	99117	3/4" NPT	0.45	0.20
FT100NPT	99118	1" NPT	0.45	0.20

## HEAVY-DUTY SHELL CUTTERS FOR CAST/DUCTILE IRON

Catalog No.	Item Code	Shell Size	Corp. Stop Size	Cutting Depth	Weight	
					Lbs	kg
△ FTSC688	99132	1 1/16"	3/4"	1.875"	0.09	0.04
△ FTSC875	99134	7/8"	1"	1.875"	0.15	0.07
△ FTSC1438	99137	1 7/16"	1 1/2"	2"	0.41	0.19
△ FTSC1750	99138	1 3/4"	2"	2"	0.57	0.26

## PVC/PE SHELL CUTTERS, PL SERIES

Catalog No.	Item Code	Shell Size	Corp. Stop Size	Cut Max. Wall Thickness	Weight	
					Lbs	kg
PL688	04385	1 1/16"	3/4" NPT & AWWA	1 1/8"	0.2	0.1
PL875	04386	7/8"	1" NPT & AWWA	1 1/8"	0.2	0.1
PL1438	04387	1 7/16"	1 1/2" NPT & AWWA	1 1/8"	0.5	0.2
PL1750	04392	1 3/4"	2" NPT & AWWA	1 1/8"	0.7	0.3

## ACCESSORIES

Catalog No.	Item Code	Description
FTPLAA	04423	Arbor Assembly (adapter) used with 1 1/2" & 2" PVC/PE Shell Cutters, PL1438 & PL1750
FTPLSAA	94198	Coupling Nut (adapter) used with 3/4" and 1" PVC/PE Shell Cutters
CRPD25	99129	1/4" diameter Carbide Tipped Coupon Retaining Drill Bit



FT2000UNIV



FT2000UNIV on PE

Manual Feed Control



FTSC875



CRPD25



FTP2000UNIV on C900 PVC

Independent, controlled feed makes this the preferred tool for PVC taps.



FTPLSAA & PL688 attaching to coupling nut

FTPLSAA

PL688





PIPE TOOLS & VISES  
SINCE 1896



DM2100B

Smooth Jaw  
Wrenches  
p. 83

Star Feed Handle

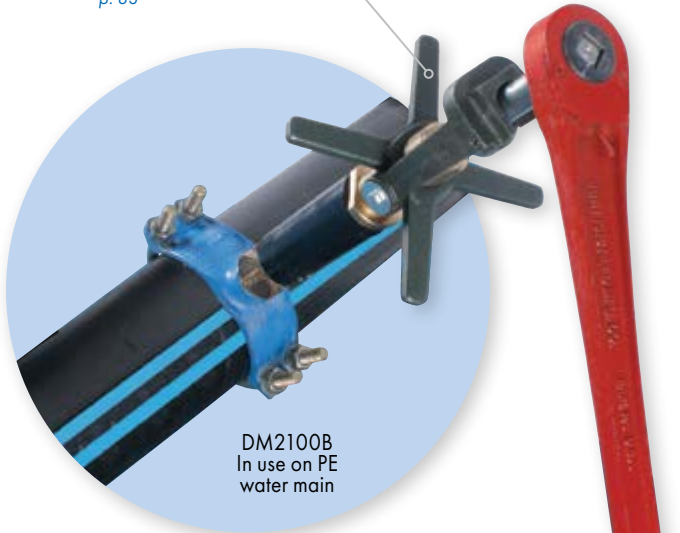

DM2100B  
In use on PE  
water main



D688

PL1438

Note: For shell cutters  
and hole cutters,  
attachment thread is  
5/8 to 18.

Slot for Easy  
Coupon Removal



HDHS1438

## Drilling Machines

### FEATURES

- Drilling Machines have a quick clamp feed mechanism requiring little adjustment.
- These machines are more compact, thus requiring less clearance than other models.

Catalog No.	Item Code	Size	Gross Weight	
			lbs	kg
△ DM2100B	09301	Base Only	49.5	22.5
△ DM1100	09302	3/4" - 1" AWWA	53.0	24.1
△ DM2100BSPT	09308	3/4" - 2" BSPT	55.5	25.2
△ DM2100	09312	3/4" - 2" AWWA	55.5	25.2
△ DM2100NPT*	09315	3/4" - 2" NPT Corp Stops	55.5	25.2
△ DM2100110*	09317	3/4" - 2" 110 Compression	55.5	25.2
△ DM2100CCNPT	09318	3/4" - 1" AWWA, 1 1/2" - 2" NPT	55.5	25.2
△ DM2100UNIVERSAL	09321	3/4" - 2" AWWA & NPT	60.0	27.3

\*Extended boring bar (#99390) needed for 2" iron body gate valves.

### D SERIES DRILL BITS FOR CAST/DUCTILE IRON

Catalog No.	Item Code	Drill Size	Corp. Stop Size	Weight	
				lbs	kg
D688	04380	1 1/16"	3/4" NPT & AWWA	0.3	0.1
D875	04381	7/8"	1" NPT	0.5	0.2
D938	04382	1 5/16"	1" AWWA	0.6	0.3

### PVC/PE SHELL CUTTERS, PL SERIES

Catalog No.	Item Code	Shell Size	Corp. Stop Size	Cut Max. Wall Thickness	Weight	
					lbs	kg
△ PL688	04385	1 1/16"	3/4" NPT & AWWA	1 1/8"	0.2	0.1
△ PL875	04386	7/8"	1" NPT & AWWA	1 1/8"	0.2	0.1
PL1438	04387	1 7/16"	1 1/2" NPT & AWWA	1 1/8"	0.5	0.2
PL1750	04392	1 3/4"	2" NPT & AWWA	1 1/8"	0.7	0.3

### HEAVY-DUTY CARBIDE-TIPPED HOLE CUTTERS FOR CAST/DUCTILE IRON

Catalog No.	Item Code	Hole Saw Size	Corp. Stop Size	Weight	
				lbs	kg
△ HDHS1438	04354	1 7/16"	1 1/2" NPT & AWWA	0.4	0.2
△ HDHS1750	04355	1 3/4"	2" NPT	0.5	0.2
△ HDHS1875	04356	1 7/8"	2" AWWA	0.6	0.3

### WHY REED?

PL Series shell cutters easily bore through even the heaviest wall PVC/PE pipe as they cut through service saddles. They retain the coupon on most cuttings.

### WHY REED?

Heavy-duty Drilling Machine is compact and lightweight to make up to 2" saddle taps. REED offers many different options to meet individual customer needs.



# More Drills, Adapters & Cutters

## PILOT DRILL

Catalog No.	Item Code	Description	Weight	
			lbs	kg
<sup>Δ</sup> HSPD	04561	1/4" Pilot Drill Bit	0.5	0.2
CRPD25	99129	1/4" Carbide-tipped Coupon Retaining Pilot Drill Bit	0.05	0.02

## ADAPTERS FOR DRILLS, HOLE CUTTERS & SHELL CUTTERS

Catalog No.	Item Code	Fits	Weight	
			lbs	kg
<sup>Δ</sup> DMHSA	08413	1 1/2" & 2" Shell & Hole Cutters	0.4	0.2
DMAPVC	94150	3/4" & 1" PVC Shell	0.5	0.2
HSAS	98457	3/4" and 1" Hole Cutter Adapter	0.45	0.2
DMDA75	98461	3/4" for D688	0.4	0.2
DMDA100	98462	1" for D875 & D938	0.5	0.2
DMCA75EXT	98481	3/4" Extended	0.4	0.2
DMCA100EXT	98482	1" Extended	0.7	0.3
DMAPVCEXT	98489	3/4" & 1" PVC Extended	0.6	0.27

## DRILLING MACHINES - CORPORATION ADAPTERS

Catalog No.	Item Code	Fits	Weight	
			lbs	kg
DMCA75	08423	3/4" AWWA	2.2	0.1
DMCA100	08424	1" AWWA	2.2	0.1
DMCA150	08425	1 1/2" AWWA	1.0	0.5
DMCA200	08426	2" AWWA	1.1	0.5
DMCA150NPT	08428	1 1/2" NPT	0.8	0.4
DMCA200NPT	08429	2" NPT	0.8	0.4
DMCA110150	08431	1 1/2" Mueller® 110 Comp	1.3	0.6
DMCA110200	08432	2" Mueller® 110 Comp	1.3	0.6
DMCA125BSPT	08434	1 1/4" BSPT Corp Adapter	2.2	1.0
DMCA150BSPT	08435	1 1/2" BSPT Corp Adapter	0.8	0.4
DMCA200BSPT	08436	2" BSPT Corp Adapter	0.8	0.4
DMCA100IPS	98499	1" IPS	0.8	0.4

## BORING BARS

Catalog No.	Item Code	Fits
DM1100BB	99304	Boring Bar
DM11BBEXT	99390	Boring Bar, Extended for 2" Iron Body Gate Valves

## CUTTER/BIT SELECTION CHART

Select the proper cutter for the proper type of pipe.

Catalog No.	Item Code	Size	Water Main Type		
			PE/PVC	Cast Iron	Cement-Lined Ductile
D688	04380	1 1/16"		X	X
D875	04381	7/8"		X	X
D938	04382	15/16"		X	X
PL688	04385	1 1/16"	X		
PL875	04386	7/8"	X		
PL1438	04387	1 7/16"	X		
PL1750	04392	1 3/4"	X		
HDHS1438	04354	1 7/16"		X	X
HDHS1750	04355	1 3/4"		X	X
HDHS1875	04356	1 7/8"		X	X

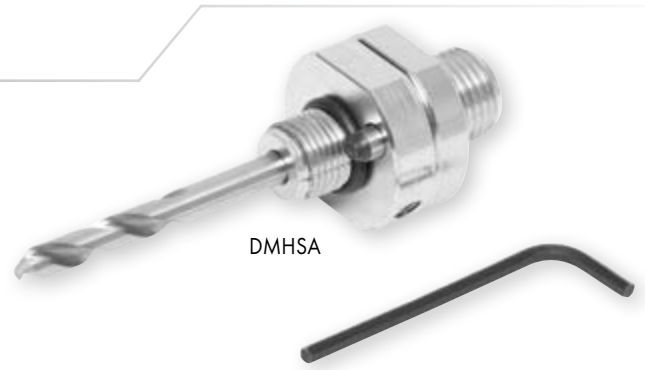



PIPE TOOLS & VISES  
SINCE 1896

# Direct Tapping Machine

## FEATURES

- Drill and tap water mains while they remain under pressure.
- Lightweight yet strong, corrosion-resistant aluminum frames are easy to carry and set-up.
- Pressure relieving valve allows for a one-step operation making it simple to use.
- Modular design allows fast and simple conversion to drilling machine.



TM1100

Smooth Jaw  
Wrenches  
pg. 83

Catalog No.	Item Code	Size	Pipe Diameter		Gross Weight	
			in-nom.	actual O.D. mm	lbs	kg
△ TM1100*	09300	3/4" - 1"	4 - 48	100 - 1300	101.8	46

\*Model ships freight.

## DRILL TAPS

Catalog No.	Item Code	Drill Size	Thread	Pipe Material	Weight	
					lbs	kg
DT75	04390	3/4"	CC	Cast/Ductile	1.1	0.5
DT100	04391	1"	CC	Cast/Ductile	1.3	0.6
DT75P	04396	3/4"	CC	C900 PVC	1.0	0.5
DT100P	04397	1"	CC	C900 PVC	1.4	0.6



TM1100  
in use



DT75

### ✓ WHY REED?

DT75 has been used by the AWWA Tapping Competition winning teams for over 25 years!

### ✓ WHY REED?

The unique three-flute design of DT75P/DT100P bores into the pipe with less effort than other drill tap designs and ensures that the coupon and cuttings are retained.



DT75P

### ✓ WHY REED?

Food-grade compound that does not contaminate water, making this compound environmentally friendly.



TS6



Flip  
Clamp

TMTC6



## TAPPING SADDLES

Catalog No.	Item Code	Description
TS12	98438	12" Saddle
TS6	98439	6" Saddle
TS8	98440	8" Saddle
TS10	98441	10" Saddle
TS4	98442	4" Saddle
TS16	98443	16" Saddle
TS18	98444	18" Saddle
TS20	98445	20" Saddle
TS24	98446	24" Saddle
TS42	98448	42" Saddle

## TAPPING COMPOUND

Catalog No.	Item Code	Description
TMTC	98425	16 oz. (.45 kg) resealable can
TMTC6	99140	6 oz. (170 g) squeezable bottle

### ✓ WHY REED?

REED's Tapping Machine is a better value than the competition and is made in the USA. TM1100 ships with all necessary parts, including the corp insertion tools. Plus, by ordering the saddles and drill taps separately, one only needs to purchase the right sizes for the job. Additionally, the Direct Tapping Machine can be converted to a drilling machine for up to 2" saddle taps, thus saving money over the purchase of an additional machine.



# Combination Drilling/Tapping Machines

## FEATURES

- Modular design allows fast and simple conversion back and forth from tapping to drilling machine.
- Quick clamp feed mechanism requires little adjustment, saving time for the operator.
- Compact design requires less digging as radius = 32" which is less than competitor models.

Catalog No.	Item Code	Description	Pipe Diameter		Gross Weight	
			in-nom.	actual O.D. mm	lbs	kg
Δ CDTM1100 *	09304	3/4" - 1" Tap & Drill	4 - 48	100 - 1200	114.4	52.0
Δ CDTM2100 *	09314	3/4" - 1" Tap, 3/4" - 2" Drill	4 - 48	100 - 1200	116.5	53.0
Δ CDTM2100110 *	09323	CDTM2100 with 110 Adapters 3/4" - 1" Tap 3/4" - 2" Drill	4 - 48	100 - 1200	116.5	53.0

 \*Model ships freight.

Taps, Bits and Cutters - p. 44 - 46

## CONVERSION KITS

Catalog No.	Item Code	Description
CDTM1CONVN	09306	TM1100 to CDTM1100
Δ CDTM2CONVN	09316	TM1100 to CDTM2100

## WHY REED?

Why REED? One combination machine assembles as a drilling machine or a direct tapping machine. Offers a cost savings versus the purchase of separate machines.



# PVC/PE Drilling Machines

## FEATURES

- Drill through the pipe wall while the system is under pressure by manual power only.
- Drill travel can handle PVC, C900 and PE wall thicknesses up to 1 1/8".
- Steel parts are plated or powder epoxy coated for corrosion resistance.

Catalog No.	Item Code	Size	Weight	
			lbs	kg
Δ DMPVCBASE	04401	3/4" - 1"	3.7	1.7
Δ DMPVC	04402	3/4" - 1"	8.4	3.8
Δ DMPVC COMPLETE	04404	3/4" - 1"	11.0	5.0
Δ DMPVC3/4	04418	3/4" Drilling Only	4.0	1.8
Δ DMPVC1	04420	1" Drilling only	4.0	1.8

## PVC/PE SHELL CUTTERS, PL SERIES

Catalog No.	Item Code	Shell Size	Corp. Stop Size	Cuts Max Wall Thickness	Weight	
					lbs	kg
Δ PL688	04385	1 1/16"	3/4" NPT & AWWA	1 1/8"	0.2	0.1
Δ PL875	04386	7/8"	1" NPT & AWWA	1 1/8"	0.2	0.1

Larger PL1438 and PL1750 do not fit the DMPVC models.

## CORPORATION ADAPTERS

Catalog No.	Item Code	Fits	Weight	
			lbs	kg
DMCA75PVC	04426	3/4" AWWA	1.5	0.7
DMCA100PVC	04427	1" AWWA	1.1	0.5
DM75CONV	98472	3/4" NPT - AWWA Converter	0.4	0.2
DMI00CONV	98473	1" NPT - AWWA Converter	0.6	0.3



DMPVC

PL688

DMPVC assembled

## WHY REED?

These shell cutters easily bore through even the heaviest wall PVC/PE pipe and retain the coupon and most cuttings.



PIPE TOOLS & VISES  
SINCE 1896

## Power Units for Tapping/Drilling

### FEATURES

- Add power to your drilling and tapping, and save hours of hand-cranking.
- Electric models use standard 110V source.

Catalog No.	Item Code	Description	Weight	
			lbs	kg
601PDTAP	05246	601PD Tapper with 1 <sup>3</sup> / <sub>16</sub> " Adapter	17.0	7.7
△ 700PDTMPDA	05276	700PD and TMPDA Adapter	34.0	15.5

Power Drives - p. 62 - 63

### ACCESSORIES

Catalog No.	Item Code	Description	Weight	
			lbs	kg
PDGFI	05277	Ground Fault Interrupter	0.8	0.4
TMPDA	08430	1 <sup>3</sup> / <sub>16</sub> " Adapter Only	4.0	1.8

Power Drive GFI - p. 63



## Manhole Hooks

### FEATURES

- Open drain covers and manhole covers with ease; choose from three different manhole hook lengths.
- Handle to head hooks offered in same plane or 90-degree rotation, depending on operator preference.
- Heavy-duty, made in USA manhole cover tool designed to handle stubborn loads.

Catalog No.	Item Code	Hook to Handle Relationship	Length		Weight	
			in	mm	lbs	kg
MH26*	02301	Same plane	26	650	3.3	1.5
MH30*	02302	Hook 90° to handle	30	760	4.0	1.8
MH36*	02303	Same plane	36	900	4.3	2.0

EXCLUSIVE FEATURE: Powder-coated surface

## Fiberglass Probe Rod

### FEATURES

- Safely locate pipe or utility lines with non-conductive rod.
- Zinc-plated, steel tip for durability.

Catalog No.	Item Code	Description	Weight	
			lbs	kg
△ FSPR4	02960	Fiberglass Soil Probe Rod 4 ft.	0.7	0.3



Heavy-duty construction and made in USA quality result in durable tools.



FSPR4





# Cordless Power Drive for Tapping & Valve Exercising

## FEATURES

- Adapts for tapping/drilling or valve exercising, with a quick drophead change.
- Provides plentiful torque without all the weight – just 15 lbs (6.8 kg).
- Safety first! Motor kick-off feature if unit experiences sudden jolt or torque burst.
- Power paddle switch stops almost immediately when released.
- Convenient carrying handle offers support for valve turning.
- Power source is Bosch® angle grinder. User to provide 18V Bosch® battery, sold separately.

Catalog No.	Item Code	Description	Weight	
			lbs	kg
CPDWW	05258	Cordless Power Drive for Waterworks Use - bare tool only, no battery	15	6.8

## ACCESSORIES

Catalog No.	Item Code	Description	Weight	
			lbs	kg
<sup>Δ</sup> CPDWWCNT	05295	Digital Counter Assembly for CPDWW	2	0.9
TMPDA	08430	<sup>13</sup> / <sub>16</sub> " Adapter only	4	1.8
VOKUCLUTCH*	05287	Utility Clutch with Over Torque Protection	7.5	3.4
★CPDWWLVHN	05296	Leverage Handle for CPDWW	3.7	1.7

\*See valve key options online

### ✓ WHY REED?

Lightweight unit with a compact shape offers cordless power for tapping and drilling or for valve exercising.

### ✓ ADD A BATTERY & CHARGER



CPDWWCNT

**NEW**

CPDWWLVHN stored on CPDWW

### ✓ CHOOSE AN ADAPTER



TMPDA



### ✓ CHOOSE A JOB



VOKUCLUTCH



### ✓ VALVE EXERCISING



### ✓ TAPPING





PIPE TOOLS & VISES  
SINCE 1896

## Valve Operator

### FEATURES

- Add power to valve exercising and maintenance work with this compact, easy-to-transport system.
- Utility Clutch offers over torque protection and adjustable torque setting feature.
- Individuals working alone can isolate a leak by shutting multiple valves easily with this time-saving tool.
- Accepts Valve Keys with 1" square shafts.

Catalog No.	Item Code	Description	Gross Weight	
			lbs	kg
<sup>▲</sup> VOKU700PD	05290	Kit includes 700PD Electric Power Drive, VOKUCLUTCH Utility Clutch, 2" Valve Key and Extension	63.8	29

### ACCESSORIES

Catalog No.	Item Code	Description	Weight	
			lbs	kg
<sup>▲</sup> VOKCNT	05291	Digital Counter	1.6	0.7
VOKCASE	05294	Case for Digital Counter	1.1	0.5



VOKU700PD



VOKCNT



VOKUCLUTCH



**VIDEO  
TRAINING**



VOKU700PD  
with  
VOKUCLUTCH  
in use

## Utility Clutch

### FEATURES

- Used for valve exercising with portable power drive.
- Drive socket accepts 1" square shafts, including REED Valve Keys.
- Safety first as utility clutch has over torque protection.
- Factory set torque of 150 lb-ft (203 Nm) with adjustable torque limits of 7 to 204 lb-ft (10-277 Nm).
- Mechanism is permanently lubricated and sealed for continued clutch performance.

Catalog No.	Item Code	Description	Weight	
			lbs	kg
VOKUCLUTCH	05287	Utility Clutch with Over Torque Protection	7.5	3.4



VOKUCLUTCH



# Valve & Curb Keys

## FEATURES

- Compact size fits in crowded utility trucks, behind pickup seats, or in car trunks.
- Heavy gauge, mechanical steel tubing shafts support a maximum torque of 200 lb-ft.
- Wide choice of attachable tools allows users to customize to their systems.
- Made in USA, REED valve keys feature strong welds at critical points.
- As a safety feature, REED valve keys bend before they break.
- Use manually with included handle or add REED CPDWW or VOKU700PD with utility clutch for power option.



For turning gate valves in the street and curb stop valves to buildings, REED offers the most complete, rugged and compact selection.



**VALVE KEY MATRIX CHART**



Catalog No.	Item Code	Description	Closed Length		Open Length		Weight	
			in	mm	in	mm	lbs	kg
VKA	02340	Valve Key for 2" Operating Nut, Adjustable Length	45	1143	81	2057	14.4	6.5
VKP	02341	Pivoting Valve Key for 2" Operating Nut, Adjustable Length	46.5	1181	82	2083	16	7.3
VKP10	02345	Pivoting Valve Key with 3 ft. Extension for 2" Operating Nut, Adjustable Length	46.5	1181	118	2997	21	9.5
VK2CK1	02346	Main Valve Key + 1" Curb Key	45	1143	81	2057	14.4	6.5
VK2CK2	02347	Main Valve Key + 2" Curb Key	45	1143	81	2057	14.5	6.6
VK3CK1WHL	02353	Main Valve Key + 1" Curb Key + valve wheel 2 prong tool	45	1143	81	2057	15.3	7.0
VK3CK1ROD	02356	Main Valve Key + 1" Curb Key + 3/8" slotted tool for curb box rods	45	1143	81	2057	18.7	8.5
VK3CK1CK2	02357	Main Valve Key + 1" Curb Key + 2" Curb Key	45	1143	81	2057	18.4	8.4
VK3CK1EXT	02358	Main Valve Key + 1" Curb Key + Extension shafts for additional 6' reach	45	1143	151.6	3850	25.7	11.7
VK3CK1EXT3	02366	Main Valve Key + 1" Curb Key + 3' Extension Shaft	45	1143	117.8	2991	19.4	8.8
VK6KIT	02368	Kit contains parts to make all VK2 and VK3 variations, using the VK3 upper shaft. VK6KIT contains 32340 (8) and (1) each 92339, 92347, 92342, 92346, 92345, 92349, 92358, 92360	45	1143	151.6	3850	42.5	19.3
VKP3CK1CK2	02369	Pivoting Valve Key + 1" Curb Key + 2" Curb Key	46.5	1181	82	2083	20.1	9.1

## ACCESSORIES

Catalog No.	Item Code	Description	Closed Length		Open Length		Weight	
			in	mm	in	mm	lbs	kg
VKPLS	92344	Lower Shaft with Pivot Key Head	43.5	1105	-	-	5.8	2.6
VKFHC	92348	Handle with Pentagon Key	26	660	-	-	3.3	1.5
VKEXT3	92351	Valve Key Extension, 3'	39.75	1010	-	-	5.0	2.3
VKEXT	92358	Valve Key Extension, 6'	39.75	1010	73.6	1869	11.3	5.1
VK2LS	92339	Lower Shaft with 2" Valve Key	43.25	1099	-	-	6.0	2.7
VKFHRK	92345	Handle plus Rod Key	40	1016	-	-	3.5	1.6
VKFWW	92349	Wheel Wrench	7.75	197	-	-	0.8	0.4

## VALVE KEY HEADS

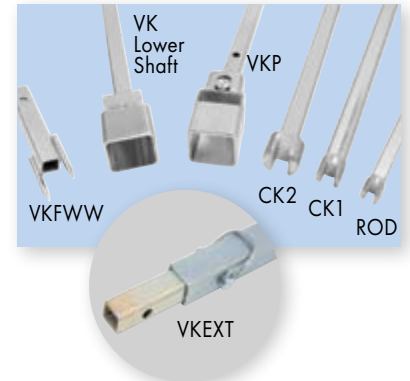

# Ratcheting Valve Keys

## FEATURES

- Ratchet handle operation reduces back strain and operator fatigue compared with using traditional valve keys.
- Closed size of under 4 foot long means they fit in crowded utility trucks, behind pickup seats, or in car trunks



Catalog No.	Item Code	Description	Closed Length		Open Length		Weight	
			in	mm	ft/in	mm	lbs	kg
VKRCK1	02349	2" Main Valve Key + 1" Curb Key & Ratchet Handle	45.5	1156	6' 7"	2.01	20.1	9.1
VKREXT	02350	2" Main Valve Key + Extension & Ratchet Handle	45.5	1156	12' 6"	3.81	26.2	11.9
VKRIEXT	02351	1" Square Key + Extension & Ratchet Handle	45.5	1156	12' 6"	3.81	26.8	12.2





PIPE TOOLS & VISES  
SINCE 1896

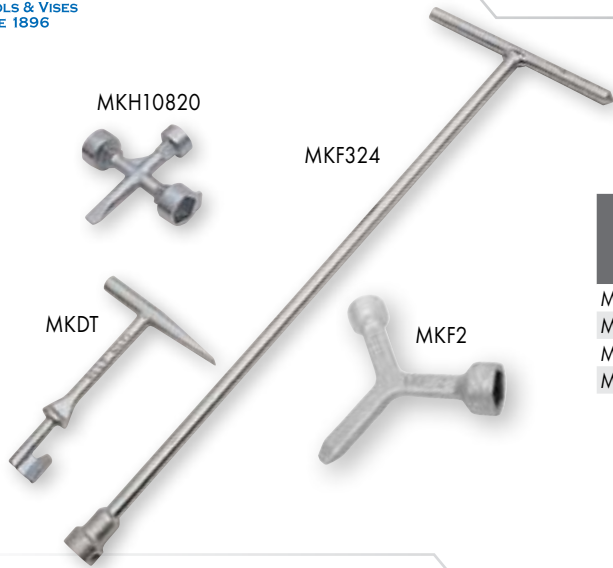

## Meter Box & Curb Box Lid Keys

### FEATURES

- Keys are plated to resist rust.
- Tough, rust-resistant materials give long life.
- Waterworks lid keys open, lock and lift lids in one single motion.

Catalog No.	Item Code	Description	Length		Weight	
			in	mm	lbs	kg
MKF2	02364	Ford® Lg. & Std. Pentagons	5.5	140	0.9	0.4
MKF324	02367	24" T w/ Std., Slotted Pentagons	24.5	622	2.4	1.1
MKDT	02375	Ductile T Skeleton	7.0	178	0.8	0.4
MKH10820	02380	Mueller® 2 Lg. & 1 Std. Pentagon	5.0	127	1.2	0.5



## Corporation Stop Key Sockets

### FEATURES

- Universal slot fits most standard corp stops and meter keys in the field.
- Corporation sockets for 3/4" - 2" corp stops.
- Handy sockets attach to 1/2" drive wrench for quick turns.

Catalog No.	Item Code	Description	Weight	
			lbs	kg
CSK	02237	Corp Stop Key Socket with Slot Width 0.54"	0.15	0.07
L25	02272	Corp Stop Key Socket with Slot Width 0.48"	0.45	0.20

# JOBSITES AROUND THE WORLD

Serving the world of hard-working tradesmen and women from our Erie, Pennsylvania location since 1896, Reed Manufacturing is still family-owned and operated, producing quality pipe tools and vises. Sold worldwide exclusively through local distributors, REED tools are the first choice of professionals everywhere.



# Torpedo Level for Waterworks

## FEATURES

- Pitch vial for easy and accurate slope measurements.
- V-groove feature for pipes.
- Three, extra strong, rare earth magnets to grab metal surfaces.
- 30° and 45° flat edge tips to measure and transfer angles.
- Thumb screw to lock on conduit and eliminate dog legs.



LV6WW

Catalog No.	Item Code	Material	Size	Description	Weight	
					lbs	kg
^ LV6WW	06214	Aluminum	0.7" x 1.25" x 6.5"	Waterworks Use	0.3	0.1

# Flare Tools for PE Water Service Lines

## FEATURES

- Flaring tool for medium and high density PE.
- Forms a permanent cold flare on polyethylene tubing.
- Allows use of standard AWWA flare fittings on CTS PE tubing.
- Hand-operated tool with vise-grip pliers.



SFPE3/4

Catalog No.	Item Code	CTS Tubing in-nom.	Weight	
			lbs	kg
SFPE3/4*	04200	3/4	1.9	0.9
SFPE1*	04202	1	2.2	1.0

EXCLUSIVE TOOL

\*EXCLUSIVE TOOL

# PE Water Service Shut-off Tool

## FEATURES

- "One size fits all" emergency shut-off tool squeezes shut PE water lines.
- Shut-off tool is zinc plated for corrosion resistance.
- Knurled grip catches and holds the pipe.
- Latch at far end holds tool closed until repair is made.



PES01

Catalog No.	Item Code	Pipe Capacity		Length		Weight	
		in-nom.	actual O.D. mm	in	mm	lbs	kg
PES01	04300	3/4 - 1	19 - 25	18	457	2.7	1.2

# Standing Shut-off Tool

## FEATURES

- Stop the flow of water in 3/4" to 1" PE plastic tubes.
- Long, 30 inch handles allow both clamping leverage and reach into pits.
- Perform shut-off from above the ditch.



SSO1C

SSO1C in use

Catalog No.	Item Code	Pipe Capacity		Length		Weight	
		in-nom.	actual O.D. mm	in	mm	lbs	kg
^ SSO1C	04281	3/4 - 1	19 - 25	43.5	1105	17.7	8.0

PE Squeeze Tools - p. 36 - 38



PIPE TOOLS & VISES  
SINCE 1896



## Hammer Flaring Tools for Copper Tubing

### FEATURES

- Make 45-degree flares with these high-quality hammer flaring tools for copper tubing.
- Ideal for use with Type K soft copper tube.
- Hardened and tempered to resist wear.

Catalog No.	Item Code	Copper Tube Size	Weight	
			lbs	kg
HF3/4	06071	3/4"	1.0	0.5
HF1	06072	1"	1.5	0.7
HF1 1/2	06077	1 1/2"	3.2	1.5
HF2	06078	2"	4.9	2.2

### PRESSURE-RELIEVING HAMMER FLARES

Catalog No.	Item Code	Copper Tube Size	Length		Weight	
			in	mm	lbs	kg
PRHF3/4	06073	3/4"	7.5	191	2.0	0.9
PRHF1	06074	1"	7.5	191	2.3	1.0

## Rerounding Tools

### FEATURES

- Compression fittings rely on round copper tubing and these tools help restore a round shape to the tubing.
- Steel construction for endurance.
- Rerounds CTS copper tube size.
- For safety, use with a soft-faced, brass hammer.

Catalog No.	Item Code	Copper Tube Size	Length		Weight	
			in	mm	lbs	kg
RR3/4	06081	3/4"	6	152	0.7	0.3
RR1	06082	1"	6.5	165	1.3	0.6
RR1 1/2	06084	1 1/2"	8	203	2.8	1.3
RR2	06085	2"	9	229	5.4	2.5



### WHY REED?

Safety first! REED always recommends brass hammers with Flare Tools, Pressure Relieving Hammer Flares and Rerounding Tools.

## Brass Hammer

### FEATURES

- Shock-absorbing brass hammer.

Catalog No.	Item Code	Weight	
		lbs	kg
HAM3	06088	2.8	1.3



# Copper Shut-off Tools

## FEATURES

- Tools shut-off and reshape soft copper tube service lines.
- Redesigned with detachable, ratchet drive handle, shut-off tools store compactly in a heavy-duty case.
- Support handle can be positioned in two different, perpendicular angles for job demands.
- CSO1R features steel castings to provide superior tool strength.
- Hard anodized, aluminum castings of CSO2R reduce tool weight and give long service life.

Catalog No.	Item Code	Tube Capacity		Weight	
		in-nom.	actual O.D. mm	lbs	kg
△ CSO1R	08201	3/4 - 1	19 - 25	10.5	4.8
△ CSO2R	08203	1 1/4 - 2	32 - 51	15.6	7.1



# Round It® Straightener/Rerounder

## FEATURES

- Take the trouble out of handling copper rolls by using REED Round It® tools for straightening and rerounding.
- Provides the needed leverage to guide tube into position for fit-ups.
- Removes mild kinks, frequently preventing the need to cut out a section and to splice-in a short piece.
- Tools will quickly pay for themselves in material, labor and time savings.

Catalog No.	Item Code	Capacity nom.	Length		Weight	
			in	mm	lbs	kg
△ CSR2	08220	1 1/2" & 2"	38	965	22.0	10.0
△ RCR3/4	08226	3/4"	18	457	4.5	2.0
△ RCR1	08227	1"	18	457	4.5	2.0
△ RCR341	08228	3/4" & 1"	18	457	5.5	2.5





PIPE TOOLS & VISES  
SINCE 1896

### WHY REED?

Rugged construction of pump, along with screen/filter system and battery adapter plates set this pump apart from any competitive methods.



## Pump Stick® Cordless Water Transfer Pump

### FEATURES

- Battery operated pump transfers water at 15 gallons (57 liter) per minute.
- Compatible with different battery brands by changing the battery adapter plate.
- Rugged, contractor grade, impact-resistant glass filled polycarbonate parts and aluminum body for durability and strength.
- Secure, magnetic hose connection provides fast, reliable link.
- Quick change motor to lessen downtime.
- Multiple screen/filter options to suit the job.



CP15-38B

Catalog No.	Item Code	Description	Weight	
			lbs	kg
△ CP15-38B	08140	CP15 Pump with 2 ft. Hose and CP15CRSCRN Coarse Screen, Base Model – add a Battery Adapter Plate to fit Operator's Battery	4.5	2.0
△ CP15-38	08141	CP15 Pump Complete with 2 ft. Hose, 18V 4Ah Bosch® Battery & Charger in Case	12.0	5.5
△ CP15-38E	08144	CP15 Pump - Export Only	6.3	2.9
★ △ CP15-38DB2	08146	CP15 Pump with 2ft Hose, Coarse Screen, Dewalt® Adapter Plate & (2) 20V 4Ah Dewalt® Batteries	10.0	4.5

\*Sold only in US and Canada, due to battery and charger.

### BATTERY ADAPTER PLATES

Catalog No.	Item Code	Description
△ CPAPDEW	98140	Fits most DeWalt® 18V - 20V slide style batteries
△ CPAPMIL	98141	Fits most Milwaukee® 18V slide style batteries
△ CPAPMAK	98149	Fits most Makita® 18V slide style batteries
△ CPAPBOSCH	98139	Fits most Bosch® 18V slide style batteries

**ADD A BATTERY ADAPTER PLATE**  
Allows for battery choice



CPAPMIL



CPAPDEW



**FULL ACCESSORIES CHART ON P. 86**

## Meter Pit Pump

### FEATURES

- Lightweight PVC construction.
- Rugged construction is ideal for any standing water.

Catalog No.	Item Code	Description	Capacity: Ounces per Stroke	Weight	
				lbs	kg
MP175-6	02327	1 3/4" x 36" Manual Pump with 72" Hose	35	2.0	0.9

### REPLACEMENT HOSE

Catalog No.	Item Code	Description	Weight	
			lbs	kg
HOSE175-6	42326	1 3/4" X 6' (1829 mm) Replacement Hose for MP175-6	0.8	0.4

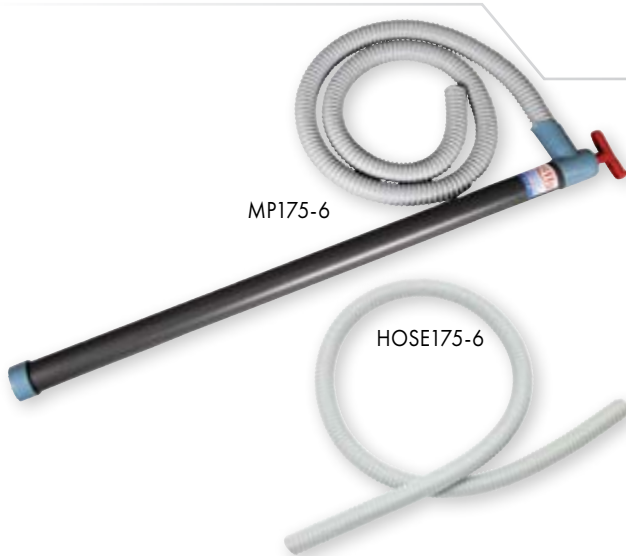

MP175-6

HOSE175-6



## SECTION 4

# ***THREADERS & DIES***

R12+ Dropheads  
R12+ Segmental Dies  
R12+ Threader Sets  
Universal Die Head  
Universal Dies  
Enclosed Dropheads  
Enclosed Ratchet Threader Sets  
Block Dies  
Double Deep™ Oilers  
Threadguard Cutting Oil  
5301PD Power Drive  
700PD Power Drive  
601PD Power Drive





PIPE TOOLS & VISES  
SINCE 1896



DHR121 1/2NPT

## R12+ Dropheads

### FEATURES

- R12+ Dropheads ship with longer lasting, high speed steel dies whereas competitor uses alloy dies.
- Precise, segmental dies inside cut an impressive, true thread.
- Drophead with installed dies thread steel and stainless steel pipe.
- Dropheads can be used manually or with a power drive.

Catalog No.	Item Code	Size	Weight	
			lbs	kg
DHR12 1/2NPT	05626	1/2" NPT	3.6	1.6
DHR12 3/4NPT	05628	3/4" NPT	3.6	1.6
DHR12 1NPT	05630	1" NPT	4.2	1.9
DHR12 1 1/4NPT	05632	1 1/4" NPT	4.7	2.1
DHR12 1 1/2NPT	05634	1 1/2" NPT	5.1	2.3
DHR12 2NPT	05636	2" NPT	5.4	2.5

Double Deep™ Oiler / Oil - p. 61

## R12+ Segmental Dies

### FEATURES

- R12+ Segmental Dies are made of high speed steel which lengthens die life.
- Dies are right-hand configuration only and uncoated.
- Precision manufactured by modern CNC machines.

Catalog No.	Item Code	Size	Standard Pack	Weight	
				lbs	kg
R12DN 1/2	05606	1/2" NPT	4	0.2	0.1
R12DN 3/4	05608	3/4" NPT	4	0.2	0.1
R12DN 1	05610	1" NPT	4	0.3	0.1
R12DN 1 1/4	05612	1 1/4" NPT	4	0.3	0.1
R12DN 1 1/2	05614	1 1/2" NPT	4	0.5	0.2
R12DN 2	05616	2" NPT	4	0.5	0.2

Double Deep™ Oiler / Oil - p. 61

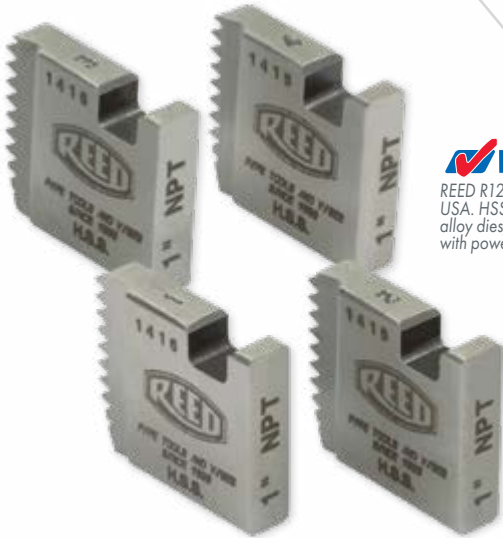

### WHY REED?

REED R12+ series is made in USA. HSS dies last longer than alloy dies, especially if used with power drives.

R12DN1

## R12+ Threader Sets

### FEATURES

- Choose the number of dropheads needed for an NPT set.
- Case provides secure position of threader components for transport.

Catalog No.	Item Code	Size	Weight	
			lbs	kg
R12NPT-3	05712	1/2", 3/4", 1" NPT	16.4	7.5
R12NPT-4	05714	1/2", 3/4", 1", 1 1/4" NPT	21.1	9.6
R12NPT-6	05720	1/2", 3/4", 1", 1 1/4", 1 1/2", 2" NPT	31.6	14.4
△ R12NPT-6-BOX	05721	1/2" - 2" NPT with R12BOX	52.6	23.9

### ACCESSORIES

Catalog No.	Item Code	Description	Weight	
			lbs	kg
R12RRHC	05638	Ratchet Ring & Handle	5.0	2.3
△ R12BOXRPF	05717	Heavy-Duty Plastic Case with R12+ Drophead Slots	6.5	2.9

NOTE: Most REED R12+ threader sets DO NOT include the R12 case.

Order separately as #05717.

Double Deep™ Oiler / Oil - p. 61



R12NPT-6-BOX



## Universal Die Head

### FEATURES

- R811 die head holds any NPT or BSPT thread or bevel-type REED Universal Dies.
- Works on machines with through head oiling capabilities.

Catalog No.	Item Code	Pipe Capacity		Weight	
		in-nom.	actual O.D. mm	lbs	kg
R811	05380	1/8 - 2	3 - 50	12.5	5.7

Double Deep™ Oiler / Oil - p. 61  
5031PD Power Drives - p. 62



R811

## Universal Dies

### FEATURES

- REED Universal Dies give clean threads and long die life as proven by years of field and lab testing.
- HSS universal dies withstand high temperature without losing hardness which means they cut faster than alloy dies at room temperature.

Catalog No.	Item Code	Size	Material	Standard Pack	Weight	
					lbs	kg
UHNI-2-3/4	05815	1/2" - 3/4" NPT	HSS	4	1.5	0.7
UHNI-2	05820	1 - 2" NPT	HSS	4	1.3	0.6
UHSI-2-3/4	05825	1/2" - 3/4" NPT	HSS for Stainless	4	1.5	0.7
UHSI-2	05830	1" - 2" NPT	HSS for Stainless	4	1.3	0.6



UHNI-2

### WHY REED?

REED Universal Dies are made in the USA, lab tested and proven, then field tested and approved by threading specialist contractors and industrial users. Years of on-going lab and field tests have shown REED Universal Dies give clean threads and long die life.

## Enclosed Dropheads

### FEATURES

- Ready-to-use dropheads have the dies in-line, every time, making them quick to grab and use.
- Low-cost, disposable, compact yet high-quality dies.

Catalog No.	Item Code	Description	Weight	
			lbs	kg
R11 1/4NPT	05210	1/4" NPT Drophead	1.2	0.5
R11 3/8NPT	05211	3/8" NPT Drophead	1.2	0.5
R11 1/2NPT	05212	1/2" NPT Drophead	1.3	0.6
R11 3/4NPT	05213	3/4" NPT Drophead	1.4	0.6
R11 1NPT	05214	1" NPT Drophead	1.9	0.9
R11 1 1/4NPT	05215	1 1/4" NPT Drophead	2.0	0.9
R15 1 1/2NPT	05226	1 1/2" NPT Drophead	3.7	1.7
R20 2 NPT	05227	2" NPT Drophead	3.4	1.5

### ACCESSORIES

Catalog No.	Item Code	Description	Weight	
			lbs	kg
R11SC	05230	Ratchet Ring and Handle for R11 Dropheads	3.7	1.7
R20SC	05231	Ratchet Ring and Handle for 2" Drophead	5.4	2.5
R20 ADAPTER	05234	Adapts R11 Dropheads to R20SC	0.6	0.3

601PD Power Drive - p. 63



### XTRA VALUE

R15 1 1/2NPT

R20 ADAPTER

R20SC

R11SC with R11 3/8NPT



PIPE TOOLS & VISES  
SINCE 1896



### ✓ WHY REED?

No alignment problems as dies are enclosed within each drophead. These complete dropheads are less expensive than models requiring individual segment replacement.

DH81-2



## Enclosed Ratchet Threader Sets

### FEATURES

- Dies are enclosed within each drophead which ensures superior alignment.
- High quality dies and dropheads made on CNC machines.
- Dies are alloy steel, heads are malleable iron.
- Sets are the lightest drophead sets available, size for size.

Catalog No.	Item Code	Range	Heads Include	Weight	
				lbs	kg
DH82-4	05200	1/2" - 1 1/4"	4	12.2	5.5
DH82-3	05201	3/8" - 1 1/4"	5	13.4	6.1
DH81-2	05202	1/4" - 1"	5	12.7	5.8
DH81-4	05204	1/2" - 1"	3	10.1	4.6
DH84-4	05222	1/2" - 2"	6	22.8	10.4
DH84-5	05223	3/4" - 2"	5	21.5	9.8
DH84-6	05224	1" - 2"	4	20.0	9.1
DH84-7	05225	1 1/4" - 2"	3	18.2	8.3

EXCLUSIVE  
TOOL



2SP1 1/2

## Block Dies

### FEATURES

- REED's block dies thread both carbon steel and stainless steel with no die change required.
- Produce the most precise thread of any die.
- The double-threaded throats literally pull the die onto the pipe making it easy to start threading.

Catalog No.	Item Code	Size	Pipe Material	Thread	Block Size	Stocks that Dies Fit	Weight	
							lbs	kg
2SP1/2	05524	1/2"	Steel / Stainless Steel	NPT	4 x 4	S84, SD84, 84	3.0	1.4
2SP3/4	05526	3/4"	Steel / Stainless Steel	NPT	4 x 4	S84, SD84, 84	2.9	1.3
2SP1	05528	1"	Steel / Stainless Steel	NPT	4 x 4	S84, SD84, 84	3.4	1.5
2SP1 1/4	05530	1 1/4"	Steel / Stainless Steel	NPT	4 x 4	S84, SD84, 84	3.2	1.5
2SP1 1/2	05532	1 1/2"	Steel / Stainless Steel	NPT	4 x 4	S84, SD84, 84	3.0	1.4
2SP2	05534	2"	Steel / Stainless Steel	NPT	4 x 4	S84, SD84, 84	2.6	1.2

### ✓ WHY REED?

The REED block die is machined as a unit to ensure perfect threads and to eliminate the danger of inserting a chaser into the wrong slot.



SD84-4



### ADJUSTABLE GUIDE THREADER SETS

Catalog No.	Item Code	Range	Dies Included	Block Size	Weight	
					lbs	kg
SD84-4	05151	1/2" - 2"	6	4" x 4"	29.1	13.2

Double Deep™ Oiler / Oil - p. 61

# Double Deep™ Oiler System

## FEATURES

- Oiler includes oil gun with 60 inch hose, drip pan, bucket, handle and one gallon of thread cutting oil.
- Deep (8 ½ inch) steel bucket, steel drip pan/chips tray, and sturdy aluminum oil gun for OLBUCKET1 demonstrate the quality construction.
- Metal splash guard OLGUARD with magnetic feet breaks up liquid motion to keep the oil in the bucket by interrupting centripetal force.
- OLLID locking lid protects oil from weather events and transit messes.

Catalog No.	Item Code	Description	Weight	
			lbs	kg

△ OLBUCKET1\* 06150 Double Deep™ Oiler 21.0 9.5

\*EXCLUSIVE FEATURE: 60 inch hose, steel drip pan

## ACCESSORIES

Catalog No.	Item Code	Description
△ OLHOSE	97370	60" Hose (1524 mm)
OLDRIPPAN	97375	Metal Drip Pan/Chip Tray - 20 Gauge Sheet Steel
OLOILBUCKET	97376	Metal Bucket - 20 Gauge Sheet Steel
OLBUCKETF	97380	Oil Pan Strainer
OLGUN	97395	Oil Gun
OLLID	06153	Protective Lid with Latches
OLGUARD*	06155	Splash Guard with Magnets

\*EXCLUSIVE TOOL

### WHY REED?

Much stronger and longer-lasting than oilers with plastic drip pans/chip trays. 60" (not 54") hose maximizes user convenience.



OLBUCKET1

EXCLUSIVE FEATURE



OLLID



OLGUARD assembly



OLGUARD

# Threadguard Cutting Oil

## FEATURES

- Successful hand and machine threading depends on this quality cutting oil.
- Offered in both clear and dark oil.
- Prolongs die life.

Catalog No.	Item Code	Type	Size	Bottles to Case	Weight	
					lbs	kg
OGD	06120	Dark Oil	Gallon	6	8.2	3.7
OGC	06112	Clear Oil	Gallon	6	7.9	3.6



OGC

OGD

### WHY REED?

Higher lubricity for longer die life and faster cutting speed.



OGD in use



PIPE TOOLS & VISES  
SINCE 1896

Flat Workspace  
on Housing



## 5301PD Power Drive

### FEATURES

- Durable units for power drive functions.
- 5301PD can be combined with REED's RG6S or RGC0MBO2 for power roll grooving.
- 5301PDCOMP "complete" comes with HSS (High Speed Steel) Universal Dies for best threads.

Catalog No.	Item Code	Description	Pipe Capacity		Gross Weight	
			in-nom.	actual O.D. mm	lbs	kg
△ 5301PD	05301***	Power Drive 38 RPM, 120V with Footswitch only	1/8 - 2 Pipe 1/4 - 2 Bolt**	3 - 50 Pipe 6 - 50 Bolt	93.0	43.0
△ 5301PDCOMP*	05303***	Power Drive Complete 38 RPM, 120V, NPT Dies	1/8 - 2 Pipe 1/4 - 2 Bolt**	3 - 50 Pipe 6 - 50 Bolt	208.0	95.0



\*COMPLETE units contain Power Drive, Footswitch, Tripod, Carriage with Lever, Pipe Cutter, Reamer, R811 Universal Die Head, Transporter, Oiler, 1 gallon Threadguard Cutting Oil and one set each High Speed Steel Universal Dies: 1/2" - 3/4" and 1" - 2" NPT.  
\*\* Bolt dies not available from REED.

\*\*\*Model ships freight.

### WHY REED?

Exclusive, flat top of housing is ideal for placing tools. 5301PD includes long-lasting high speed steel (HSS) dies, not alloy dies. All steel oiler (not plastic) with 60" (not 54") hose included with complete units.

### ACCESSORIES

Catalog No.	Item Code	Description	Weight	
			lbs	kg
5301PDTP	05305	Tripod Only	26.0	11.8
5301PDTRANSPRTR	05306	Transporter	28.0	12.7
5301PDCARRIAGE	05307	Carriage with Lever	16.0	7.3
5301PDREAMER	05308	Reamer	6.8	3.1
5301PDCUTTER	05309	1/8" - 2" Pipe Cutter	8.5	3.9
5301PDBA-PR	95570	Brush Assembly	0.05	0.02
PDGFI	05277	Ground Fault Interrupter	0.8	0.4

Roll Groovers - p. 66  
Double Deep™ Oiler / Oil - p. 61  
Universal Die Head and Dies - p. 59



## 700PD Power Drive

### FEATURES

- Workhorse model, designed for threading pipe and conduit up to 2" (50 mm) in diameter.
- Vinyl-coated handle provides better electrical safety to the user.
- Neoprene sealed switch helps keep dirt out and prolongs switch life.
- Turns at 28 RPM.

Catalog No.	Item Code	Description	Pipe Capacity		Gross Weight	
			in-nom.	actual O.D. mm	lbs	kg
△ 700PD	05270	Power Drive 120V, 60 Hz	1/8 - 2	3 - 50	40.5	18.4
△ 700PDSET	05272	Power Drive 120V, 60 Hz, six R12+ Dropheads for 1/2" - 2" NPT	1/2 - 2 NPT	12 - 50	67.0	30.5

### SAFETY ARM

Catalog No.	Item Code	Description	Pipe Capacity		Weight	
			in-nom.	actual O.D. mm	lbs	kg
700V	05275	Safety Arm (vise) for 700PD & 700APD Power Drives	1/8 - 2	3 - 50	7.0	3.2

R12+ Dropheads and Dies - p. 58  
Power Units for Drilling / Tapping - p. 48  
Double Deep™ Oiler / Oil - p. 61  
Utility Clutch - p. 50

^ WARNING: Cancer and Reproductive Harm. www.P65Warnings.ca.gov



700PD

700V  
Safety Arm

700PD and  
Oiler on Tripod



# 601PD Power Drive

## FEATURES

- One of the lightest electric power drives on the market.
- Safety arm and carrying case included.
- A great alternative to hand-threading; uses enclosed dropheads.

Catalog No.	Item Code	Description	Pipe Capacity		Gross Weight	
			in-nom.	actual O.D. mm	lbs	kg
601PD	05240	Power Drive & Safety Arm, 110-120 volts, 50/60 Hz, with Case	1/4 - 1 1/4	6 - 32	25.0	11.4

## SAFETY ARM

Catalog No.	Item Code	Description	Pipe Capacity		Weight	
			in-nom.	actual O.D. mm	lbs	kg
601V	05242	Replacement Safety Arm for 601PD Power Drive	1/4 - 1 1/4	6 - 32	5.7	2.6

## POWER DRIVE UNIT WEIGHT

A measure of the tool weight the operator must support.

Catalog No.	Item Code	Weight	
		lbs	kg
601PD	05240	15	6.8
700PD	05270	31	14.3

Enclosed Dropheads - p. 59  
Power Units for Drilling / Tapping - p. 48



**ELIMINATE HAND THREADING**



# Power Drive GFI

## FEATURES

- Stay safe and use a ground fault interrupter with electric power tools.

Catalog No.	Item Code	Description	Weight	
			lbs	kg
PDGFI	05277	Ground Fault Interrupter	0.8	0.4



# OUR MISSION

REED will develop a growing market position in the pipe tool industry by providing the most innovative and the highest quality tools, the best customer service, the lowest total cost and the greatest value to distributors and tool users.

REED seeks to utilize very effective personnel, the most modern, cost-effective equipment, and total quality management concepts in order to achieve challenging objectives. REED also seeks to provide a great place to work, to be environmentally responsible and to be a good corporate citizen.



## SECTION 5

# TEST PUMPS & GROOVERS

Drill Powered Hydrostatic Test Pumps  
Electric Hydrostatic Test Pumps  
Hydrostatic Test Pump  
Combo Roll Groovers  
Portable Roll Groovers





# Drill Powered Hydrostatic Test Pumps

## FEATURES

- Compatible with any 1/2" electric or 18V cordless drill.
- Keeps the worksite clear as no drop cord is needed when used with a cordless drill.
- Lightweight since the power source is separate.
- Works on commercial and residential water systems.
- Storage case keeps the pump clean and organized.



DPHTP500  
in use



DPHTP500

Catalog No.	Item Code	Power Source	Inlet	Outlet	Maximum Capacity				Weight	
					gal/min	l/min	psi	bar	lbs	kg
Δ DPHTP500	08177	Drill powered (drill not included)	3/4" GHT	1/2" NPSM	1.3	4.5	500	34	8.5	3.9
Δ DPHTP500E	08179	Drill powered (drill not included)	1/2" BSPT*	1/2" NPSM	1.3	4.5	500	34	8.8	4.0

\*Pump includes inlet adapter from 3/4" GHT (garden hose thread) to 1/2" BSPT for easy connection to BSPT fittings.



# Electric Hydrostatic Test Pumps

## FEATURES

- Smooth running, quiet 3/4 HP motor available in 110V or 220V.
- Includes a 15 foot (4.6m) high pressure hose for filling the system.
- Pumps are self-priming and work with pressurized or non-pressurized water supply.
- Available with or without protective cage.



EHTP500



EHTP500C

Safety Cage

Catalog No.	Item Code	Power Source	Inlet	Outlet	Maximum Capacity				Weight	
					gal/min	l/min	psi	bar	lbs	kg
Δ EHTP500	08170	110V, single phase 50/60 Hz	3/4" GHT	1/2" NPSM	2	7	500	34	37.5	17.0
Δ EHTP500E	08171	220V, single phase 50/60 Hz	1/2" BSPT	1/2" NPSM	2	7	500	34	37.5	17.0
Δ EHTP500C	08175	110V, single phase 50/60 Hz	3/4" GHT	1/2" NPSM	2	7	500	34	48.0	21.8
Δ EHTP500CE	08176	220V, single phase 50/60 Hz	1/2" BSPT	1/2" NPSM	2	7	500	34	48.0	21.8



# Hydrostatic Test Pump

## FEATURES

- Economical, reliable pump is designed for pressure tests.
- This manual pump is budget-friendly for occasional testing.
- Pumps are self-priming and work with pressurized or non-pressurized water supply.
- For more frequent system tests, consider REED EHTP500 and DPHTP500 power pumps.

Catalog No.	Item Code	Capacity	Weight	
			lbs	kg
Δ HTP300	08150	300 psi	8.6	3.9
Δ HTP1000	08160	1000 psi	8.6	3.9



HTP300



HTP1000



PIPE TOOLS & VISES  
SINCE 1896

### WHY REED?

Two wrenches ship with RGCOMBO2. There's a straight handle for power grooving and an angled handle for easier, more efficient manual grooving.



RGCOMBO2



### RELIABLE, EFFORTLESS TRACKING!



RGCOMBO2 in use

### WHY REED?

Combo Roll Groover has compact, lightweight design with built-in handle for improved mounting and transporting. All gears enclosed in the casing minimize debris entering tool. Consistent tracking makes this tool great to use time after time.



VIDEO TRAINING



## Combo Roll Groovers

### FEATURES

- Perform both power and manual roll grooves with ease.
- May be used manually on pipe "in air" or on a pipe stand.
- Slide block and groove roll angle ensures tool tracks around the pipe accurately while making a groove.
- Adapts to power grooving with REED 5301PD and other comparable power drives.
- Requires 10 1/4 inches of clearance for in air grooving.
- Built to last with reinforced components at key points to yield a longer useful tool life

Catalog No.	Item Code	Pipe Material	Pipe Capacity		Gross Weight	
			in-nom.	mm	lbs	kg
RGCOMBO2	09200	Schedule 10 and 40 for Steel, Stainless Steel & Aluminum pipe	1 1/4" - 6"	32 - 152	31.4	14.3

### GROOVER SELECTION CHART

Select the roll groover for the proper type of pipe.

Catalog No.	Item Code	Power Source	Tool Weight		Pipe Capacity		Type of Pipe			
			lb	kg	in-nom.	mm	SS	Steel	Al	PVC
RG6S	08500	Power	22.7	10.3	1 1/4" - 6" Sch. 5S to 40	32 - 152	X	X	X	X
RG26S	08510	Manual	19.1	8.7	2" - 6" Sch. 5S to 10S 2" - 3" Sch. 40	51 - 152 51 - 76	X	X	X	X
RGCOMBO2	09200	Power or Manual	27.5	12.5	1 1/4" - 6" Sch. 10 to 40	32 - 152	X	X	X	

### WHY REED?

Combines the compact RG6S design for long life with sealed, heavy-duty bearings and up to 6" capacity.



RG6S with 5301PDCOMP

RG6S



RG26S in use on steel pipe



RG26S

### WHY REED?

Angled rollers keep the RG26S groover on the pipe and in-line; will not "walk off" pipe. It uses heavy-duty bearings, hardened and ground shafts, and rollers mounted in a ductile iron housing for durability. Ratchet wrench is convenient to use in tight spaces.

## Portable Roll Groovers

### FEATURES

- Finger-adjust depth screw and gauge on RG6S for quick, accurate and repeatable groove depths.
- Angled rollers on RG26S keep the groover on the pipe and in-line.
- RG26S ratchet wrench is easy to use in tight places.

Catalog No.	Item Code	Pipe Material	Pipe Capacity		Gross Weight	
			in-nom.	mm	lbs	kg
RG6S	08500	Steel, Stainless Steel, Aluminum, PVC	1 1/4" - 6" Sch. 5S to 40 4"-6" PVC	32 - 152	26.6	12.1
RG26S	08510	Steel, Stainless Steel, Aluminum, PVC	2" - 6" Sch. 5S to 10S, 2" - 3" Sch. 40	51 - 152, 51 - 76	20	9.1

5301PD Power Drives - p. 62

## SECTION 6 ***VICES***

Tripod Pipe Vises  
Pipe Jacks  
Chain Vises  
Field Pipe Vise  
Yoke Pipe Vises  
Utility Workshop Vises  
Mid-Line Vises  
Brass Vise Jaw Caps





PIPE TOOLS & VISES  
SINCE 1896

# Tripod Pipe Vises

## FEATURES

- Patented, reversible double-sided bowtie jaws.
- Very sturdy due in part to the overlapping hinges on the lower tray and the adjustable tray clamp.
- Handle grip is positioned for best portage of the folded tripod.
- Sides on folding tray keep tools and parts safe from falling or rolling off.



**PATENTED  
DESIGNS**

**EXCLUSIVE  
FEATURES**

Catalog No.	Item Code	Vise Style	Pipe Capacity		Folded Length		Weight	
			in-nom.	actual O.D. mm	in	mm	lbs	kg
△ R450+	02306	Chain	1/8 - 6	10 - 178	44	1118	36.3	16.5
△ R40+	02311	Yoke	1/8 - 2 1/2	10 - 75	51	1295	39.1	17.8
△ R450EXPORT	02312	Chain	1/8 - 6	10 - 178	44	1118	36.3	16.5
△ R40EXPORT	02313	Yoke	1/8 - 2 1/2	10 - 75	51	1295	39.1	17.8
△ R450PAL*	04456	Chain with Neoprene Coated Jaws	Plastic: 1/8 - 6 Conduit: 1/8 - 2	Plastic: 10 - 178 Conduit: 10 - 51	44	1118	27.4	12.5
△ R450P	04457	Chain with Neoprene Coated Jaws	1/8 - 6	10 - 178	44	1118	36.3	16.5
△ R450C*	04458	Chain	1/8 - 6	10 - 178	44	1118	37.4	17.0
△ R470P	04459	Chain with Neoprene Coated Jaws	1/8 - 6	10 - 178	44	1118	42.0	19.1
△ R470+	09402	Chain	1/8 - 6	10 - 178	44	1118	42.0	19.1
△ R470EXPORT	02314	Chain	1/8 - 6	10 - 178	44	1118	42.0	19.1

\*EXCLUSIVE

Protect Plastic Pipe  
with Neoprene Jaw  
Side

R450PAL

Now with  
Chain for 6"  
Plastic Pipe

60% Larger  
Top Tray than  
the R450+

R470+

Crank Handle  
At 45° Angle

Padded  
Handle

Adjustable  
Tray Clamp

6" Pipe  
Capacity

Reversible  
Double-Sided  
Bowtie Jaws

Strongest  
Tray on the  
Market

Raised Lip  
Keeps  
Tools on  
Tray

Overlapping  
Hinges for  
Added Strength

R40+  
Ideal for high  
torque work

## **WHY REED?**

Tripod Pipe Vises are the sturdiest on the market. Double-sided bowtie jaws give user an extra set of jaws free! They are lightweight and feature a padded handle for carrying ease, making it the most portable and best value Tripod Pipe Vises available. Further, REED has the only Clean Room Tripod: R450C.



△ WARNING: Cancer and Reproductive Harm. [www.P65Warnings.ca.gov](http://www.P65Warnings.ca.gov)

# More About Tripod Pipe Vises

## FEATURES

- **R450+:** patented, double-sided, steel bowtie jaws (450J) for up to 6" metal pipe; chain vises are best for holding both standard and irregular shapes
- **R470+:** patented, double-sided, steel bowtie jaws for up to 6" metal pipe; 60% larger top tray than R450+ and 45 degree crank handle
- **R450P & R470P:** for plastic pipe up to 6"; jaws made for plastic / soft metal and regular metal use with patented, double-sided neoprene / steel jaws (450PJ)
- **R450C:** patented stainless steel jaws, with rubber on one side; anodized (not painted) aluminum base for corrosion protection; clear slip tube over chain; food grade lubricant; good for clean room use
- **R450PAL:** easy carry at 27.4 lbs (12.5 kg) with aluminum legs for weight-critical field uses; up to 6" plastic pipe capacity; patented, double-sided neoprene/steel jaws (450PJ)
- **R450EXPORT:** unassembled R450+ designed for low cost international shipment
- **R40+:** two-sided lower jaws for up to 2 1/2" metal pipe; best Tripod for high torque applications like hand or power drive threading
- **R40EXPORT:** unassembled R40+ designed for low cost international shipment

 **DESIGNED FOR CLEAN ROOMS**

**EXCLUSIVE TOOL**

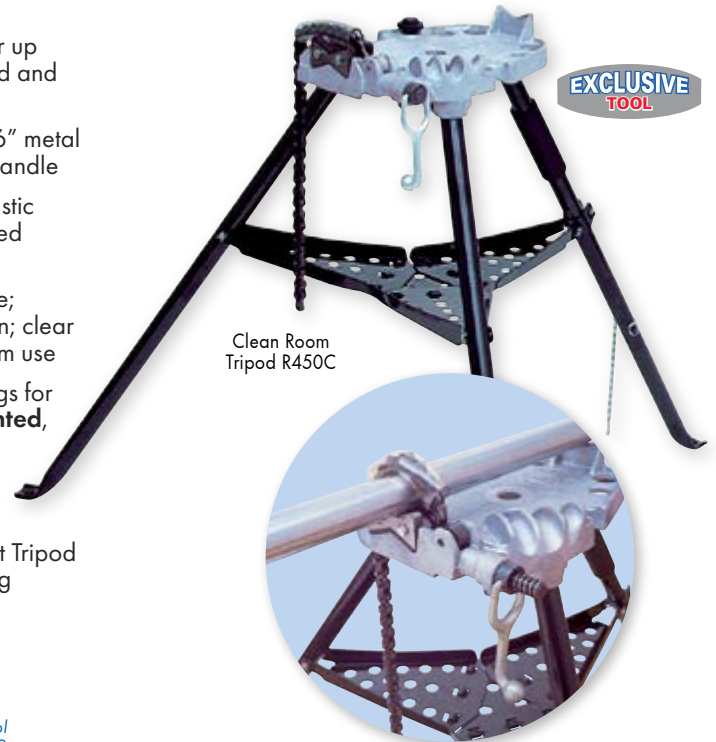

Clean Room Tripod R450C

The **R450C Clean Room Tripod** comes with reversible, stainless steel, bowtie jaws with regular jaw teeth on one side and rubber-coated jaws on the other side. The tripod has an anodized aluminum base for corrosion resistance, along with a clear polymer slip tube to inhibit marring the pipe. (The slip tube covers the chain, but is easily removed.) Chain lubricant is food grade, not petroleum based.



R450+ in use



**XTRA VALUE**



PIPE TOOLS & VISES  
SINCE 1896

## Pipe Jacks

### FEATURES

- 1" safety zone created by patented internal safety stop to protect against operator injuries.
- Folding jack, JFV, offers portability and impressive capacity.
- Three head options available to expand utility.



Catalog No.	Item Code	Description	Height Adj.		Weight Capacity		Pipe Capacity		Weight	
			in	mm	lbs	kgs	in	mm	lbs	kg
△ JFV	06370	Folding V-head Pipe Jack	28 - 49	711 - 1245	2500	1135	1/8 - 24	3 - 610	25.0	11.4

### ALTERNATE HEAD

Catalog No.	Item Code	Description	Weight Capacity		Pipe Capacity		Weight	
			lbs	kgs	in	mm	lbs	kg
JTA	06351	Ball Transfer Head Attachment (pair)	1000	455	3/8 - 12	10-300	4.6	2.1



## Chain Vises

### FEATURES

- Chain vises grip pipe and irregular shapes well due to the flexibility of the chain sections.
- Three-sided jaws are standard on REED chain vises, allowing jaw face rotation (2x) before replacement.
- Cast hole in vise permits secure mounting to truck or bench.



Catalog No.	Item Code	Pipe Capacity		Weight	
		in-nom.	actual O.D. mm	lbs	kg
CV2	02510	1/8 - 2 1/2	10 - 75	9.3	4.2
CV4	02520	1/8 - 4	10 - 114	14.6	6.6
CV5	02530	1/8 - 5	10 - 141	15.5	7.0
CV6	02540	1/4 - 6	14 - 168	28.4	12.9
CV8	02550	1/2 - 8	21 - 219	46.3	21.0
CV12*	02560**	1 - 12	25 - 335	111.0	50.5

\*EXCLUSIVE SIZE



\*\*Model ships freight.

### WHY REED?

REED chain vises save money because they come standard with three-sided jaws. Only REED has a 12" capacity chain vise.



# Field Pipe Vise

## FEATURES

- Designed for heavy-duty, pre-trench or field work.
- Vise works by tightening the chain of the smooth jaws, clamping the pipe to the stand.
- Perfect for supporting work during cutting operations using REED Hinged Cutters, Rotary Pipe Cutters, and the Universal Pipe Cutter.

Catalog No.	Item Code	Pipe Capacity		Weight	
		in-nom.	actual O.D. mm	lbs	kg
FPV20*	06027	2 - 20	50 - 500	20.6	9.4

\*To create legs and backbone, use 1 1/2" nominal diameter Sch. 40 steel pipe.

## LEGS AND BACKBONE

Catalog No.	Item Code	Description	Weight	
			lbs	kg
FPVBLS	96014	Legs (40" each) and Backbone (6 ft. long)	50.0	22.7

**LARGE DIAMETER PIPE? NO PROBLEM!**



# Yoke Pipe Vises

## FEATURES

- Best choice for all pipe work because there are four points of contact for the jaws to grip the pipe.
- REED yoke vises are solidly built, and provide the powerful grip required for demanding pipe fitting and threading operations.
- Hardened, high carbon steel jaws for toughness and long life.

Catalog No.	Item Code	Pipe Capacity		Weight	
		in-nom.	actual O.D. mm	lbs	kg
R0	02420	1/8 - 2	10 - 60	6.7	3.0
R1	02430	1/8 - 2 1/2	10 - 75	9.8	4.5
R2	02440	1/8 - 3 1/2	10 - 102	16.3	7.4
R3	02450	1/8 - 4 1/2	10 - 127	25.0	11.4
64	02460	1/4 - 6	14 - 168	49.0	22.3
65*	02470**	1 - 8	32 - 219	80.0	36.4
66*	02480**	1 1/2 - 12	48 - 335	168.0	76.4

\*EXCLUSIVE SIZES

\*\*Model ships freight.

**WHY REED?**  
Only REED makes yoke vises in 8" and 12" capacities.

**EXCLUSIVE SIZES**

**WHY REED?**

Double-faced lower jaws on R Series vises allow reversal before replacement.



# Utility Workshop Vises

## FEATURES

- Standard utility vise features a swivel base for flexibility.
- Rubber washers on the handle reduce finger pinching injuries.
- Strong vise body construction of 30,000 PSI gray cast iron.
- Workbench sized vise for normal, utility use.
- Cast vise with pipe jaws, anvil and horn.

Catalog No.	Item Code	Throat Depth*		Jaw Width		Jaws Open <sup>Ω</sup>		Weight	
		in	mm	in	mm	in	mm	lbs	kg
24 1/2C	01522	2 1/2	64	4 1/2	115	4	102	17.4	7.9
25 1/2C	01532	3	76	5 1/2	140	5	127	27.0	12.3
26 1/2C	01542	3 3/8	86	6 1/2	165	6	152	41.0	18.6
26B	01545	4 3/16	120	6	150	6	152	60.0	27.3

\*See Illustration / <sup>Ω</sup> See Illustration

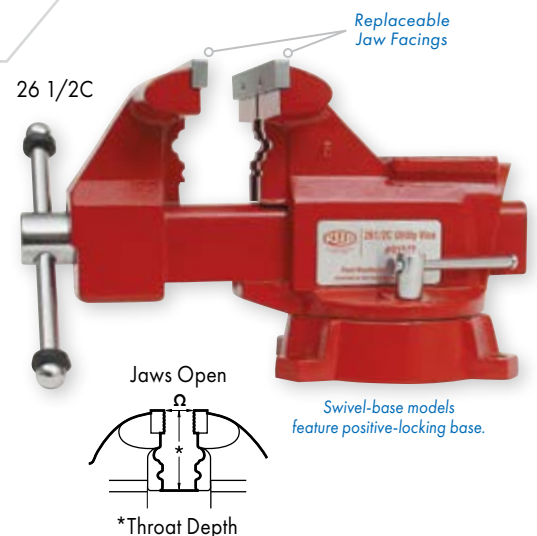



PIPE TOOLS & VISES  
SINCE 1896

Replaceable  
Jaw Facings

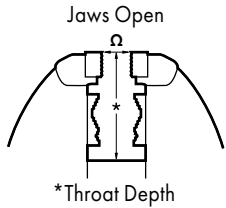

## Mid-Line Vises

### FEATURES

- Well-made, durable vise for mid-duty jobs.
- The vise screw and nut are enclosed to keep out dirt, and they are permanently lubricated.
- Rubber washers on the handle reduce finger pinching injuries.
- Always use vise of proper size and capacity to hold work object.



Swivel-base models  
feature positive-locking base.

Catalog No.	Item Code	Throat Depth*		Jaw Width		Jaws Open <sup>Ω</sup>		Pipe Capacity in-nom.	Weight	
		in	mm	in	mm	in	mm		lbs	kg
704	01385	3.45	88	4	102	4.5	114	1/2 - 2	36.0	16.4
705	01387	3.75	95	5	127	5.5	140	1/4 - 2 1/2	47.0	21.4
706	01389	4.10	104	6	152	5.7	146	1/4 - 3 1/2	61.0	27.7
708	01390	4.75	120.7	8	203	8.25	209.6	1/4 - 3 1/2	81.8	37.2

\* See Illustration / <sup>Ω</sup> See Illustration



Vises have enclosed screw assembly for all-weather protection.

## Brass Vise Jaw Caps

### FEATURES

- Universal jaw facings fit simply bending back the "ears."
- Convert any REED vise jaw facing to a smooth surface with proper sized brass caps.

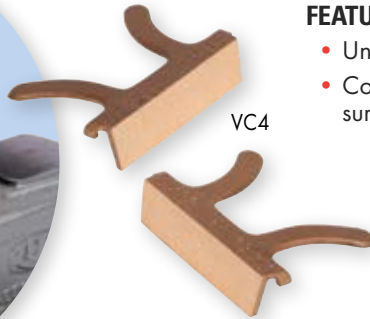
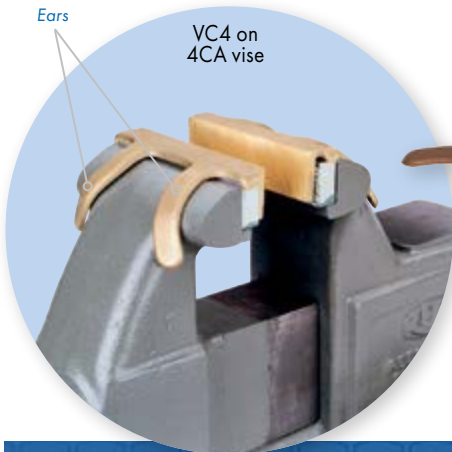

Catalog No.	Item Code	Jaw Width	Weight	
			lbs	kg
VC4	01570	4" / 102mm	1.0	0.5
VC5	01580	5" / 127mm	1.8	0.8
VC6	01590	6" / 152mm	2.7	1.2

# TRAINING VIDEOS

REED has a dynamic library of training videos in English with some in other languages. Viewing a demonstration often makes tool use more understandable, no matter the language. Visit [videos.reedmfgco.com](http://videos.reedmfgco.com) or [youtube.com/ReedManufacturing](https://www.youtube.com/ReedManufacturing) for the full collection.



[videos.reedmfgco.com](http://videos.reedmfgco.com)



LOOK FOR  
THIS ICON



A high speed connection is recommended.



## SECTION 7

# WRENCHES & SOCKETS

Pipe Wrenches  
Chain Wrenches - Heavy-Duty  
Aluminum Pipe Wrenches  
Strap Wrenches  
Adjustable Wrenches  
Torque Wrenches for Cast Iron Soil Pipe  
Square Drive Ratchet Wrenches  
Thru-Bolt™ Utility Sockets  
Extended Sockets  
Thru-Bolt™ Ratchet Wrenches  
Basin Wrench  
One Hand Wrenches  
Operator's Wrench  
Valve Packing Wrenches  
Valve Wheel Wrenches  
Smooth Jaw Wrenches  
Hydrant Wrenches  
Ratcheting Hydrant Wrench





PIPE TOOLS & VISES  
SINCE 1896



**STRAIGHT**

RW14

RWO14

**OFFSET**

**WHY REED?**

No minimum order quantities or standard package requirements on wrenches or parts.



**EXCLUSIVE FEATURES**

WA14

**EXCLUSIVE SIZES**

**WHY REED?**

REED chain wrenches offer by far the most sizes and are longer lasting with up to twice as many chain slots as any competitive tool. This spreads the force across more chain slots and provides greater operator safety.

Turning direction can be reversed without unhooking the chain.

## Pipe Wrenches - Heavy-Duty

### FEATURES

- Workhorse pipe wrench model delivers on performance and durability.
- Solid steel pin in the heel jaw strengthens REED heavy-duty pipe wrenches.
- High-tensile, ductile iron handle and hardened, alloy steel parts withstand the heaviest demands.
- Offset wrenches provide longer swing and better access to hard-to-reach places.

### STRAIGHT

Catalog No.	Item Code	Pipe Capacity		Length		Weight	
		in-nom.	actual O.D. mm	in	mm	lbs	kg
RW8	02120	1/8 - 1	10 - 33	8	203	1.0	0.5
RW10	02130	1/8 - 1 1/2	10 - 48	10	254	1.9	0.9
RW12	02140	1/8 - 2	10 - 60	12	305	2.9	1.3
RW14	02150	1/4 - 2	14 - 63	14	356	3.6	1.6
RW18	02160	1/4 - 2 1/2	14 - 75	18	457	6.1	2.8
RW24	02170	1/4 - 3	14 - 90	24	610	9.9	4.5
RW36	02180	1/4 - 5	14 - 141	36	914	15.6	7.1
RW48	02190	1 1/2 - 6	48 - 168	48	1219	32.7	14.9

### 45° OFFSET

Catalog No.	Item Code	Pipe Capacity		Length		Weight	
		in-nom.	actual O.D. mm	in	mm	lbs	kg
RWO10	02220	1/8 - 1 1/2	10 - 48	10	254	1.7	0.8
RWO14	02230	1/4 - 2	14 - 63	14	356	3.5	1.6

REED pipe wrench parts are interchangeable with most major, heavy-duty U.S. brands, including Ridgid®, of straight, 45° offset and end wrenches from 18" - 48". Parts available include hook jaw, heel jaw and pin, coil and flat spring, and nut.

## Chain Wrenches - Heavy-Duty

### FEATURES

- Chain wrenches provide safe, reliable and powerful torque.
- Dual, reversible jaws allow ratchet action in both directions without removing the chain wrench from the pipe.
- Useful for all types of pipe fitting, from waterworks to plumbing.
- REED offers more sizes than any competitor with chain wrenches to fit from 1/8" all the way up to 18" diameters.

Catalog No.	Item Code	Pipe Capacity		Length		Max O.D.		Chain Tensile Strength lbs	Weight	
		in-nom.	actual O.D. mm	in	mm	in-nom.	actual O.D. mm		lbs	kg
WA14	02040	1/8 - 2	10 - 60	14	362	4.6	117	5,500	3.2	1.5
WA18	02050	1/4 - 2 1/2	14 - 75	18	445	5	127	9,150	6.0	2.7
WA24	02060	1/4 - 3	14 - 90	24	610	5.8	147	9,150	8.4	3.8
WA36	02070	1/2 - 4 1/2	21 - 127	33	832	7.1	180	14,350	16.4	7.5
WA48*	02080	1 - 6	33 - 168	44	1118	8.5	216	20,500	29.4	13.4
WA60*	02090	1 1/2 - 8	48 - 225	46	1175	11	279	23,700	47.0	21.4
WA72*	02092**	2 1/2 - 12	73 - 324	46	1175	13	330	29,150	80.0	36.4
WA84*	02094**	2 1/2 - 18	73 - 457	46	1175	18	457	29,150	90.0	40.9

\*EXCLUSIVE SIZES

\*\*Model ships freight.

# Aluminum Pipe Wrenches - Heavy-Duty

## FEATURES

- Light and strong pipe wrench design.
- Heat-treated titanium-aluminum alloy handle for max strength.
- REED models offer tight tolerances for a snug wrench.
- Beefy housing yields a strong wrench.
- For overhead pipe work, aluminum pipe wrenches offer a lightweight, reliable solution for operators to get the job done.
- Offset wrenches provide longer swing and better access to hard-to-reach places.

## STRAIGHT

Catalog No.	Item Code	Pipe Capacity		Length		Weight	
		in-nom.	actual O.D. mm	in	mm	lbs	kg
ARW10	02093	1/8 - 1 1/2	10 - 48	10	254	1.1	0.5
ARW14	02095	1/4 - 2	14 - 63	14	356	2.1	1.0
ARW18	02097	1/4 - 2 1/2	14 - 75	18	457	3.5	1.6
ARW24	02099	1/4 - 3	14 - 90	24	610	5.7	2.6
ARW36	02101	1/4 - 5	14 - 141	36	914	10.9	5.0
ARW48	02102	1 1/2 - 6	48 - 168	48	1200	18.5	8.4

## 90° OFFSET

Catalog No.	Item Code	Pipe Capacity		Length		Weight	
		in-nom.	actual O.D. mm	in	mm	lbs	kg
ARWO14	02202	2	50	14	350	1.9	0.9
ARWO18	02204	2 1/2	65	18	450	3.2	1.5

REED aluminum pipe wrench parts are interchangeable with most major U.S. brands, including Ridgid®, of straight, 90° offset and end wrenches from 18" - 48". Parts available include hook jaw, heel jaw and pin, coil and flat spring, and nut.



**STRAIGHT**

**OFFSET**

ARWO14

ARW14  
in use

**WHY REED?**

Tight tolerances on the REED models mean a snug wrench and rugged housing yields a strong wrench.

# Strap Wrenches

## FEATURES

- Gripping power without scratching or deforming plastic or polished metal pipe.
- Ductile iron handle and extremely strong, polyester strap.
- Wrap strap around object and through tool.
- ASW12A30 offers an extra-long strap for reach around larger pipe diameters and a strong, aluminum handle to reduce overall tool weight for the operator.

## DUCTILE IRON HANDLE

Catalog No.	Item Code	Pipe Capacity		Tube Capacity		Handle Length		Weight	
		in-nom.	actual O.D. mm	actual O.D. in	actual O.D. mm	in	mm	lbs	kg
△ SW12A30	02247	1/8 - 5	10 - 127	7 1/2	190	12	305	1.7	0.8
△ SW12A	02248	1/8 - 2	10 - 63	3 1/2	90	12	305	1.6	0.7
△ SW18A	02249	1 - 5	33 - 127	6	150	18	458	2.6	1.2
△ SW24A	02250	2 - 12	60 - 324	14	350	24	610	5.1	2.3
△ SW18A48	02255	1 - 12	33 - 305	12	300	18	458	2.9	1.3
△ SW24A72	02236	2 - 18	60 - 457	20	508	24	610	5.1	2.3

## ALUMINUM HANDLE

Catalog No.	Item Code	Pipe Capacity		Tube Capacity		Handle Length		Weight	
		in-nom.	actual O.D. mm	actual O.D. in	actual O.D. mm	in	mm	lbs	kg
△ ASW12A30	02232	1/8 - 5	10 - 127	7 1/2	190	12	305	0.9	0.4



SW12A30

ASW12A30



SW18A

SW24A  
in use

Extra-long 72" (183 cm) strap on SW24A72 covers large diameters.



PIPE TOOLS & VISES  
SINCE 1896

## Adjustable Wrenches

### FEATURES

- Design angle allows for close quarter work on hex nuts.
- Precision-ground jaw slides make for the smoothest action.
- Triple-coated, nickel-chrome exterior finish on CW models is corrosion-resistant.
- Blackened finish on CWB models improves grip for work in slippery conditions.
- Standard thumb adjustment for tightening the jaws.

### CHROME FINISH

Catalog No.	Item Code	Capacity		Length		Weight	
		in-nom.	actual O.D. mm	in	mm	lbs	kg
CW4	02199	7/16	13	4	114	0.1	0.05
CW6	02201	3/4	20	6	152	0.3	0.1
CW8	02203	15/16	25	8	203	0.5	0.2
CW10	02205	1 1/8	30	10	254	0.8	0.4
CW12	02207	1 3/8	35	12	305	1.4	0.6
CW15	02209	1 11/16	40	15	381	2.7	1.2
CW18	02211	2 1/16	50	18	457	4.7	2.1
CW24	02218	2 1/2	63	24	610	7.9	3.6

### BLACKENED FINISH

Catalog No.	Item Code	Capacity		Length		Weight	
		in-nom.	actual O.D. mm	in	mm	lbs	kg
CWB6	02212	3/4	20	6	152	0.3	0.1
CWB8	02213	15/16	25	8	203	0.5	0.2
CWB10	02214	1 1/8	30	10	254	0.8	0.4
CWB12	02215	1 3/8	35	12	305	1.4	0.6
CWB15	02216	1 11/16	40	15	381	2.7	1.2
CWB18	02217	2 1/16	50	18	457	4.7	2.1



## Comfort Grip - Adjustable Wrenches

### FEATURES

- For durability and hand comfort, REED uses a thick, long-lasting comfort grip coating.
- Design angle allows for close quarter work on hex nuts.
- Precision-ground jaw slides make for the smoothest action.
- Standard thumb adjustment for tightening the jaws.
- Comfort grip provides a more secure handhold.

Catalog No.	Item Code	Capacity		Length		Weight	
		in-nom.	actual O.D. mm	in	mm	lbs	kg
△ CW6GRIP	02906	3/4	20	6	152	0.3	0.1
△ CW8GRIP	02908	15/16	25	8	203	0.5	0.2
△ CW10GRIP	02910	1 1/8	30	10	254	1.0	0.5
△ CW12GRIP	02912	1 3/8	35	12	305	1.5	0.7

These are comfort grips only, they are not made for electrical insulation.



# Torque Wrenches for Cast Iron Soil Pipe

## FEATURES

- Ratcheting action is fast and maximum torque is preset.
- Sturdy zinc body with steel components.
- Guaranteed accurate to  $\pm 10\%$ .

Catalog No.	Item Code	Hex Size	Torque		Length		Weight	
			inch pounds	Newton meter	in	mm	lbs	kg
△ TW516	02298	5/16"	60	6.8	6	152	0.9	0.4
△ TW38	02300	3/8"	80	9.0	5.8	148	0.9	0.4



# Square Drive Ratchet Wrenches

## FEATURES

- Made to fit only one size of square part/bolt.
- Wrench both ratchets and reverses.
- Great for ratcheting line-up clamps for welding steel pipe and for other process piping needs.

## HEAVY-DUTY

Catalog No.	Item Code	Square Size	Handle	Handle Length		Weight	
				in	mm	lbs	kg
△ L16-7/8	02292	7/8"	Cast	16.4	420	4.3	2.0
△ RWR13/16	40383	13/16"	Cast	19.5	495	5.2	2.4

## VALUE LINE

Catalog No.	Item Code	Square Size	Handle	Handle Length		Weight	
				in	mm	lbs	kg
△ L104-7/8	02671	7/8"	Stamped	16.4	420	2.5	1.1
△ L104-1	02672	1"	Stamped	16.4	420	2.4	1.1

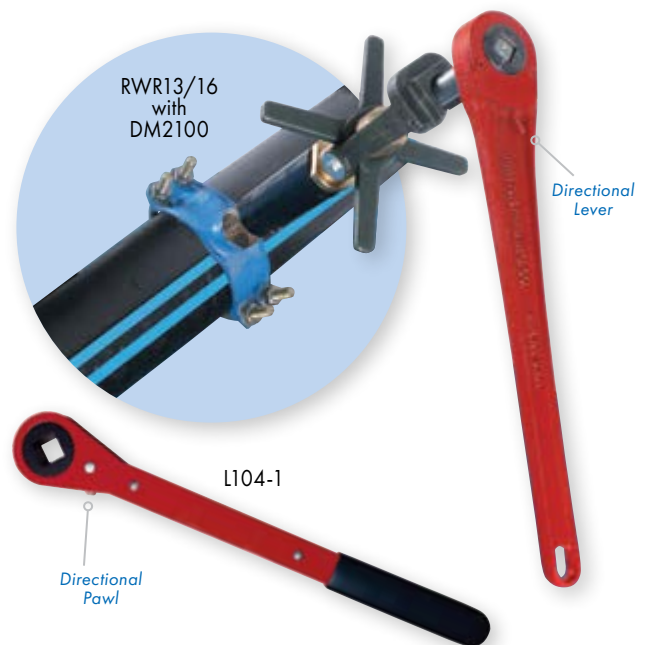

# REED ASSOCIATIONS





PIPE TOOLS & VISES  
SINCE 1896



L515 Set



L564

### ✓ WHY REED?

L564 features a Quick Release™ button along with an adjustable handle for hard-to-reach spots.



L150



L51



L500 and L17 on Service Saddle



L14



M27

### ✓ WHY REED?

REED Thru-Bolt™ ratchet handles and sockets substantially reduce the time required to tighten or remove nuts so assembly time and cost are cut considerably.

# Thru-Bolt™ Utility Socket Sets

## FEATURES

- Sets include a variety of standard hex sockets, one handle and a metal toolbox.
- Heavy-duty, cast handle with Quick Release™ feature.
- Work fast for tightening or loosening nuts.

## STANDARD

Catalog No.	Item Code	Handle	Sockets	Weight	
				lbs	kg
△ L511	02284	L500	7/8", 15/16", 1 1/8", 1 1/4" and L25 corp stop key socket	6.8	3.1
△ L515	02285	L500	3/4", 7/8", 15/16", 1 1/16", 1 1/8", 1 1/4" and L25 corp stop key socket	8.9	4.0
△ L514	02286	L564	3/4", 7/8", 15/16", 1 1/16", 1 1/8", 1 1/4" with adjustable angle handle	9.5	4.3

## METRIC

Catalog No.	Item Code	Handle	Sockets	Weight	
				lbs	kg
△ L514M	02245	L564	19mm, 22mm, 24mm, 27mm, 30mm, 32mm with adjustable angle handle	9.5	4.3
△ L515M	02246	L500	17mm, 19mm, 22mm, 24mm, 27mm, 30mm, 32mm	8.9	4.0

## INDIVIDUAL HEX SOCKETS - INCHES

Catalog No.	△ L10	△ L12	△ L14	△ L15	△ L16	△ L17	△ L18	△ L20
Item Code	02264	02265	02266	02267	02268	02269	02270	02271
Hex Size	5/8"	3/4"	7/8"	15/16"	1"	1 1/6"	1 1/8"	1 1/4"

## INDIVIDUAL HEX SOCKETS - METRIC

Catalog No.	△ M17	△ M19	△ M22	△ M24	△ M27	△ M30	△ M32
Item Code	02274	02275	02276	02277	02278	02279	02280
Hex Size	17 mm	19 mm	22 mm	24 mm	27 mm	30 mm	32 mm

## RATCHET WRENCH HANDLES (STANDARD AND METRIC)

- Choose from malleable iron cast handles or lower cost, steel stamped handles.
- Quick Release™ socket retention permits fast socket changes.
- L564 features an adjustable handle for hard-to-reach spots.

Catalog No.	Item Code	Handle	Socket Retention	Handle Length		Weight	
				in	mm	lbs	kg
△ L50	02258	Cast	Retaining Ring	11	280	1.5	0.7
△ L51	02259	Cast	Retaining Ring	13	330	1.7	0.8
△ L500	02260	Cast	Quick Release™	13	330	1.7	0.8
△ L150	02261	Stamped	Retaining Ring	11	280	1.4	0.6
△ L151	02262	Stamped	Retaining Ring	13	330	1.7	0.8
△ L564	02263	Cast & Adjustable	Quick Release™	16	420	3.5	1.6

# Extended Sockets

## FEATURES

- Extended length, impact grade sockets.
- Kits includes all socket sizes in a heavy-duty case.
- Zinc and black chromate finish holds up to heavy work.
- Six-point sockets for maximum contact area.

Catalog No.	Item Code	Hex Size(s)	Length	Weight	
				lbs	kg
EDS12	02622	3/4"	6 1/2"	1.5	0.7
EDS14	02624	7/8"	6 1/2"	1.6	0.7
EDS15	02625	15/16"	6 1/2"	1.6	0.7
EDS17	02626	1 1/16"	6"	1.5	0.7
EDS18	02628	1 1/8"	6"	1.5	0.7
EDS20	02630	1 1/4"	6"	1.5	0.7
EDSK6	02645	3/4", 7/8", 15/16", 1 1/16", 1 1/8" and 1 1/4"	See Chart	9.7	4.4

## ACCESSORY

Catalog No.	Item Code	Description	Handle Length		Overall Length		Weight	
			in	mm	in	mm	lbs	kg
SCFR	40208	1/2" male square drive wrench	13	330	15	381	1.9	0.86



# Thru-Bolt™ 4-in-1 Ratchet Wrenches

## FEATURES

- Carry one wrench for all your jobs with four sockets on one wrench.
- Length and shape of handle yield maximum leverage.
- Sockets are permanently mounted on the handle, meaning no loose sockets.
- Rugged grip handle construction for a secure hold.
- Sealed ratchets on workhorse L4N1XP provide best performance and extra protection for jobsite conditions.

Catalog No.	Item Code	Sockets	Application	Handle Length		Weight	
				in	mm	lbs	kg
△ L4N1	02690	1 1/4" & 1 1/16"	Mechanical joints and restraints, repair clamps, service saddles	17	432	2.5	1.1
		1 1/8" & 1 1/16"	Gas and water industry couplings, repair clamps, service saddles, flange bolts				
		1 1/8" & 15/16"	Flange bolts, friction clamps, hydrant break flange and some bonnet bolts				
△ L4N1XP	02692	1 1/4" & 1 1/16"	Mechanical joints and restraints, repair clamps, service saddles	17	432	2.1	1.0
		1 1/8" & 1 1/16"	Gas and water industry couplings, repair clamps, service saddles, flange bolts				
		1 1/8" & 15/16"	Flange bolts, friction clamps, hydrant break flange and some bonnet bolts				



**LESS DIRT MORE WORK**

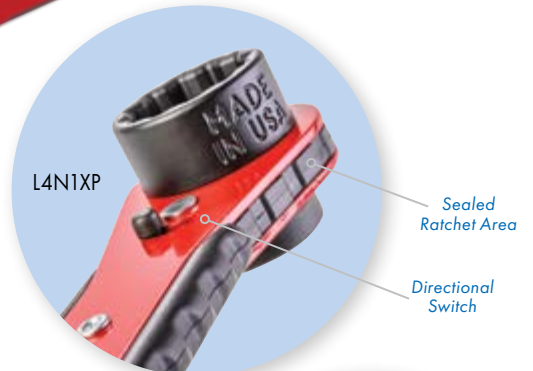

**WHY REED?**  
L4N1XP is designed to withstand the most severe, in-ditch environments due to sealed ratchet area.



**XP MODEL FOR SUPERIOR PERFORMANCE**



PIPE TOOLS & VISES  
SINCE 1896



L2N1ADJ



L2N1ADJ  
in use

## Thru-Bolt™ 2-in-1 Adjustable Ratchet Wrenches

### FEATURES

- Reversible, adjustable head with easy-to-use wing nut for positioning.
- Two socket sizes back-to-back give double use to the wrench.
- Head pivots and locks in 30 degree intervals.
- Adjustable head allows easy access to MJ bolts on the bottom of the pipe.

Catalog No.	Item Code	Sockets	Application	Handle Length		Weight	
				in	mm	lbs	kg
△ L2N1ADJ	02695	1 1/4" & 1 1/16"	Mechanical joints and restraints, repair clamps, service saddles	17	432	2.3	1.1

**TWO SOCKETS  
ONE TOOL**



L2017

LHM2275

**METRIC  
SIZES**

**NO LOST  
SOCKETS**

## Thru-Bolt™ 2-in-1 Dual Socket Wrenches

### FEATURES

- Combines two popular socket sizes into one dual-head tool.
- Rugged construction of handle and ratchet mechanism.
- Thru-Bolt™ design works on nuts on any threaded length.
- Value line wrenches have colored-coded handles for quick recognition of wrench.

### HEAVY-DUTY

Catalog No.	Item Code	Sockets	Application	Handle Length		Weight	
				in	mm	lbs	kg
△ LHM2275	02225	3/4" & 7/8" 19mm & 22mm	Hymax™ Reducer Couplings	13	330	2.2	1.0
△ L2017	02251	1 1/4" & 1 1/16"	Mechanical joints and restraints, repair clamps, service saddles	13	330	2.45	1.1
△ L1817	02252	1 1/8" & 1 1/16"	Gas and water industry couplings, repair clamps, service saddles, flange bolts	13	330	2.4	1.1
△ L1815	02253	1 1/8" & 15/16"	Flange bolts, friction clamps, hydrant break flange and some bonnet bolts	13	330	2.3	1.0

### VALUE LINE

Catalog No.	Item Code	Sockets	Application	Handle Length		Weight	
				in	mm	lbs	kg
△ LVDSSET	02930	LV1815, LV2017, LVHM2275	Kit contains LV1815, LV2017 & LVHM2275	-	-	8.9	4.0
△ LV2017	02950	1 1/4" & 1 1/16"	Mechanical joints and restraints, repair clamps, service saddles - BLUE handle	13	330	2.4	1.1
△ LV1815	02952	1 1/8" & 15/16"	Flange bolts, friction clamps, hydrant break flange and some bonnet bolts - GREEN handle	13	330	2.5	1.1
△ LVHM2275	02954	3/4" & 7/8" 19mm & 22mm	HYMAX® Reducer Couplings - YELLOW handle	13	330	2.3	1.0



LV2017

LVDSSET

**XTRA  
VALUE**





## Basin Wrench

### FEATURES

- Forged jaws are spring-loaded for one-hand ratcheting.
- Telescoping body extends for extra reach.

Catalog No.	Item Code	Pipe Capacity		Length		Weight	
		in-nom.	actual O.D. mm	in	mm	lbs	kg
BW125	11601	3/8 - 1 1/4	10 - 30	10 - 17	250 - 425	1.8	0.8

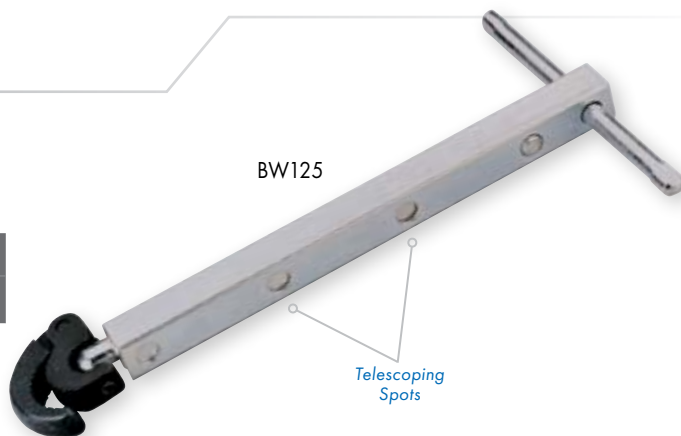

## One Hand Wrenches

### FEATURES

- The original and still the best for working in tight places.
- Spring-loaded jaws quickly grip many shapes.
- Saves time loosening nut due to ratchet action jaws; unlike a pipe wrench which cannot ratchet on a fitting.
- Ratchets for easy, one-hand operation.

Catalog No.	Item Code	Capacity-Fittings		Pipe Capacity		Length		Weight	
		in	mm	in-nom.	actual O.D. mm	in	mm	lbs	kg
MW1 1/4*	02281	3/8 - 1 1/4	27 - 48	3/4 - 1 1/2	27 - 48	16	394	3.1	1.4
MW 3/4*	02289	1/8 - 3/4	17 - 33	3/8 - 1	17 - 33	11	267	1.2	0.5

\*EXCLUSIVE SIZES



Ratchets for fast one-hand operation in hard-to-reach places. No adjustment necessary.



## Comfort Grip - One Hand Wrench

### FEATURES

- Special hand grip provides ergonomic advantages of higher torque and less hand fatigue.
- Saves time loosening nut due to ratchet action jaws; unlike a pipe wrench which cannot ratchet on a fitting.
- Works like a pipe wrench and provides better grip than pliers due to the jaws and tooth direction.
- This REED wrench invention features strong, forged steel, one-piece handle.

Catalog No.	Item Code	Capacity-Fittings		Pipe Capacity		Length		Weight	
		in	mm	in-nom.	actual O.D. mm	in	mm	lbs	kg
^ MW1 1/4GRIP*	02386	3/8 - 1 1/4	27 - 48	3/4 - 1 1/2	27 - 48	16	394	3.3	1.5

\*EXCLUSIVE SIZE

NOTE: These are comfort grips only. These grips are not made for electrical insulation.



Credit: Evan Berns @re.plumb



PIPE TOOLS & VISES  
SINCE 1896

**LIGHTWEIGHT**  
FOR ALL DAY USE



RF10

RF10  
in use

## Operator's Wrench

### FEATURES

- Two tools in one: serves as a pipe wrench and a valve wheel wrench.
- Lightest operator's wrench available – carry it all day long.
- Valve wheel wrench use protects hands from sharp burrs on valve wheels.

Catalog No.	Item Code	Pipe Capacity		Hook Opening		Length		Weight	
		in-nom.	actual O.D. mm	in	mm	in	mm	lbs	kg
RF10	02121	1/8 - 1	10 - 33	5/8	16	10	254	1.2	0.5

## Valve Packing Wrenches

### FEATURES

- Combination tool helps maintain valves without stripping the nuts or gouging the wheel rims.
- One end is an adjustable wrench while the other end provides leverage to turn valve wheels with up to 5/8" thick rims.
- Hook end fits O style valve wheels.
- Adjustable wrench end is great for hex nuts, including packing nuts on valve stems.



EXCLUSIVE  
TOOL

A8VO

Catalog No.	Item Code	Pipe Capacity		Hook Opening		Length		Weight	
		in-nom.	actual O.D. mm	in	mm	in	mm	lbs	kg
A8VO*	02808	15/16	25	5/8	16	8.4	213	0.6	0.3
A10VO*	02810	1 1/8	30	5/8	16	11	267	0.9	0.4
A12VO*	02812	1 3/8	35	5/8	16	12.4	315	1.5	0.7

\*EXCLUSIVE TOOL

## Valve Wheel Wrenches

### FEATURES

- Valve wheel wrenches are the solution for handling hard-to-open valves.
- Protect valve wheels from damage and burrs by choosing an appropriate hook.
- Designed to apply torque needed for valve-turning, over long periods of time.
- VWALP1 and VWALP2 are made of low sparking aluminum.
- REED designs are safer for heavy use—bending gives warning of overload.



VW10  
in use

VWALP1

VW10

VW0

VW3

VW2

Catalog No.	Item Code	Style	Material	Hook Opening		Length		Weight	
				in	mm	in	mm	lbs	kg
VW0	02830	Double-end	Forged steel	1/2 & 21/32	13 & 17	8	203	1.0	0.5
VW1	02831	Single-end	Forged steel	1	25	15	381	2.4	1.1
VW2	02832	Single-end	Forged steel	1 5/16	33	22	559	4.8	2.2
VW3	02833	Single-end	Forged steel	2	51	27	686	11.4	5.2
VW10	02834	Double-end	Forged steel	11/16 & 1	18 & 25	10	254	1.6	0.7
VWALP1	02851	Single-end	Aluminum	1 3/8	35	14	356	2.2	1.0
VWALP2	02852	Single-end	Aluminum	1 3/4	44	18	457	4.0	1.8

## Smooth Jaw Wrenches

### FEATURES

- Large capacity wrenches that will not mar chrome, brass or other fittings.
- Smooth jaws are gentle on finished and visible surfaces.
- RCORP and RCORP3 are strong with forged steel construction.

Catalog No.	Item Code	Maximum Actual Opening		Length		Weight	
		in	mm	in	mm	lbs	kg
RCORP3	02117	4 1/2	114	18.6	473	5.0	2.3
R110HEX	02111	2 5/8	67	10	254	1.6	0.7
RSPUD	02112	2 5/8	67	11	279	2.6	1.2
RCORP	02114	4 1/2	114	18	457	4.4	2.0

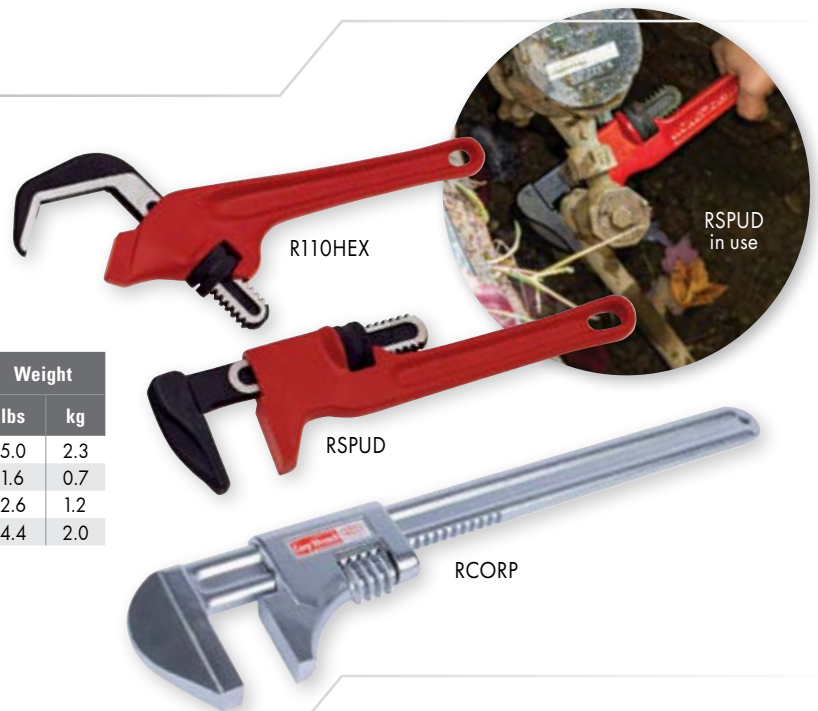

## Hydrant Wrenches

### FEATURES

- HW and HWB feature spanners for pin or lug style hose couplings up to 6 in..
- HWS45 hydrant wrench offers a spanner for the Storz® fitting and an integrated, adjustable pentagon socket for turning operating nuts.
- Forged steel HW head reduces weight yet keeps overall strength.

Catalog No.	Item Code	Pentagon		Square		Length		Weight	
		in-nom.	actual O.D. mm	in-nom.	actual O.D. mm	in	mm	lbs	kg
HWB	02283	1 3/4	45	1 1/4	31	20	500	4.5	2.0
HW	02295	1 3/4	45	1 1/4	31	20	500	4.0	1.8
^ HWS45	02390	1 3/4	45	1 1/4	31	20.5	517	4.9	2.2

### WHY REED?

Solid bar stock handle on HW and HWB is both strong and knurled for more secure gripping for critical field applications.

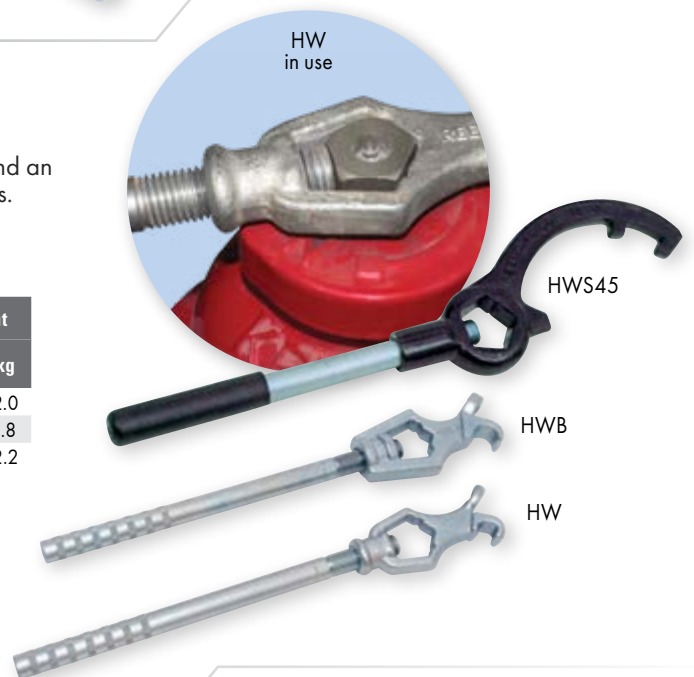

## Ratcheting Hydrant Wrench

### FEATURES

- Save valuable time with wrench's ratchet action and quick-adjusting socket.
- Adjustable, snug-fitting socket for tackling pentagon or square nuts.
- Socket adjusts quickly with the thumb screw feature.
- Heavy-duty construction.

Catalog No.	Item Code	Pentagon		Square		Overall Length		Handle Length		Weight	
		in-nom.	actual O.D. mm	in-nom.	actual O.D. mm	in	mm	in	mm	lbs	kg
^ HWFR	02397	1 3/4	42	1 1/4	32	18	457	13	330	4.4	2

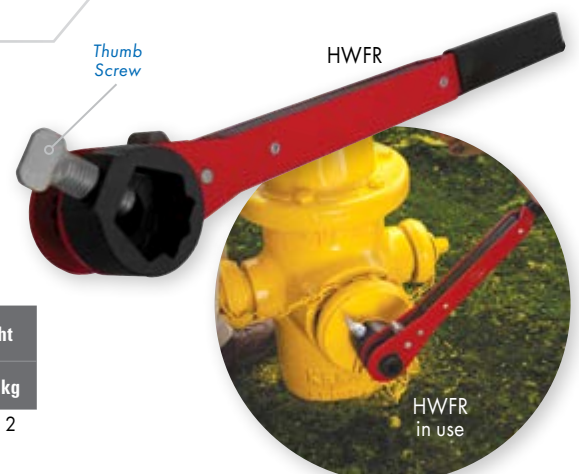

# INDUSTRIES SERVED



## **FIRE & FABRICATION**

State-of-the-art fire sprinkler tools and pipe fabrication products for the fire safety industry for industrial or commercial jobs.



## **GAS DISTRIBUTION**

Ideal for construction, maintenance, utility services or installation of pipe for transmission, distribution and service lines.



## **INDUSTRIAL / CONSTRUCTION**

Broad line of plumbing tools and specialty wrenches plus large diameter, proprietary pipe tools and vises for mechanical, electrical and general contractors.



## **OIL / GAS DRILLING & PIPELINE**

Large diameter, durable REED pipe tools are the perfect tool solutions for users in the oil and gas drilling and pipeline sectors.



## **PLUMBING / HVAC**

Full array of installation and repair tools for the professional plumbing industry for both commercial and residential projects.



## **PVF / INDUSTRIAL PROCESS PIPING**

Professional grade REED tools are on the forefront of pipe tools used for industrial process piping, with many unique solutions for those markets.



## **WATER / WASTEWATER**

REED has the waterworks tools that utility contractors, municipalities, water authorities and wastewater plants need to build and maintain efficient operations.

## SECTION 8 **GENERAL PIPE WORKING TOOLS**

Pump Stick®  
Mechanical Hot Tapping Machines  
Bi-Metal Hole Saws  
Tubing Benders  
Stud Punch  
Multi-Purpose Pipe Joiner  
Torpedo Levels  
Hack Saw  
Water Pump Pliers  
Positive Grip Pliers  
Threaded Rod Cutters





PIPE TOOLS & VISES  
SINCE 1896



CP15-38B

CP15COUP



CP15CRFLTR



CPMSTR



CPAPMIL

**ADD A BATTERY ADAPTER PLATE**

CP15-38B  
in use



**NEED MORE HOSE?**



CPHOSE7FT



CP15CASE



**VIDEO TRAINING**



# Pump Stick® Cordless Water Transfer Pump

## FEATURES

- Battery operated pump transfers water at 15 gal. (57 lt.) per minute.
- Compatible with different battery brands by changing the battery adapter plate.
- Adapter plates fit 18V-20V lithium ion, slide style batteries for some popular brands.
- Rugged, contractor grade, impact-resistant glass filled polycarbonate parts and aluminum body for durability and strength.
- Water-resistant, sealed power switch for safety.
- Secure, magnetic hose connection provides fast, reliable link.
- Quick change motor to lessen downtime.
- Multiple screen/filter options to suit the job.
- Ships with 6 inch, comfort grip handle.

Catalog No.	Item Code	Description	Weight	
			lbs	kg
△ CP15-38B	08140	CP15 Pump with 2 ft. Hose and CP15CRSCRN Coarse Screen, Base Model – add a Battery Adapter Plate to fit Operator's Battery	4.5	2.0
△ CP15-38	08141	CP15 Pump Complete with 2 ft. Hose, 18V 4Ah Bosch® Battery & Charger in Case	12.0	5.5
△ CP15-38E	08144	CP15 Pump - Export Only	6.3	2.9
★ △ CP15-38DB2	08146	CP15 Pump with 2ft Hose, Coarse Screen, Dewalt® Adapter Plate & (2) 20V 4Ah Dewalt® Batteries	10	4.5

\*Sold only in US and Canada, due to battery and charger.

## BATTERY ADAPTER PLATES

Catalog No.	Item Code	Description
△ CPAPDEW	98140	Fits most DeWalt® 18V-20V slide style batteries
△ CPAPMIL	98141	Fits most Milwaukee® 18V slide style batteries
△ CPAPMAK	98149	Fits most Makita® 18V slide style batteries
△ CPAPBOSCH	98139	Fits most Bosch® 18V slide style batteries

## HOSES

Catalog No.	Item Code	Description
CPHOSE2FT	98143	2 ft. (0.6 m) with magnetic connection
CPHOSE4FT	98144	4 ft. (1.2 m) with magnetic connection
CPHOSE7FT	98145	7 ft. (2.1 m) with magnetic connection
CP15COUP	98147	Hose Coupling with magnetic connection

## SCREENS, STRAINERS & FILTERS

Catalog No.	Item Code	Description	Contents
CP15MEDSCRN	98166	Medium Screen	3
CP15FINESCRN	98167	Fine Screen	3
CP15CRSCRN	98198	Coarse Screen	3
CP15FILTER	98168	Felt Filter, 100 Micron	2
CP15SCRFLTR	98190	Screen/Filter Assortment	Fine screen (1), medium screen (1), felt filter (1)
CPMSTR	98188	Marine Strainer, Stainless Steel	1
CPRCSTR	98189	Strainer with Domed Center	1

## ACCESSORIES

Catalog No.	Item Code	Description	Weight	
			lbs	kg
CP15CASE	98193	CP15 Standard Case, Red	4.7	2.1
△ CP15LCASE	98194	CP15 Large Case, Red	9.0	4.1
△ CP24HDLGRIP	98184	24" Handle with Grip	0.9	0.4
R5GBUCKET	01240	5-Gallon Bucket	2.1	1.0
△ CPSTAND	08145	Heavy-duty Stand for Hands-free Use	1.2	0.5



▲ WARNING: Cancer and Reproductive Harm. www.P65Warnings.ca.gov

# Mechanical Hot Tapping Machines

## FEATURES

- Hot tap steel, copper, brass or aluminum pipe for installing branch connections from 3/4" to 4" valves.
- Pressure rated 300 psi for ambient temperatures or 15 psi for steam systems.
- Eliminates the need to shut down, drain, cut, refit and refill piping systems.
- Watertight seal to allow drilling under pressure.
- Commercial and industrial applications.

Catalog No.	Item Code	Description	Valve Size	Weight	
				lbs	kg
Δ DM3MECH	08350	Kit for NPT with hole saws and arbor in storage case	3/4" - 4"	12.0	5.5
Δ DM3MECHB	08351	Base model for NPT in storage case, no hole saws or arbor	3/4" - 4"	10.0	4.5
Δ DM3MECHBSPT	08354	Kit for BSPT with hole saws, arbor in storage case	3/4" - 4"	12.0	5.5
Δ DM3MECHBSPTB	08355	Base model for BSPT in storage case, no hole saws or arbor	3/4" - 4"	10.0	4.5

## DRILL BITS

Catalog No.	Item Code	Description	Length	
			in	mm
HSPD	04561	1/4" Pilot Drill Bit	4.375	111.1
CRPD25	99129	1/4" Carbide-tipped Coupon Retaining Pilot Drill Bit	4.5	114.3

## BI-METAL HOLE SAW

Catalog No.	Item Code	Description
Δ BMHS10	43500	5/8" diameter Hole Saw
Δ BMHS14	43501	7/8" diameter Hole Saw
Δ BMHS18	43502	1 1/8" diameter Hole Saw
Δ BMHS22	43503	1 3/8" diameter Hole Saw
Δ BMHS28	43504	1 3/4" diameter Hole Saw
Δ BMHS36	43505	2 1/4" diameter Hole Saw
Δ BMHS52	43506	3 1/4" diameter Hole Saw



DM3MECH

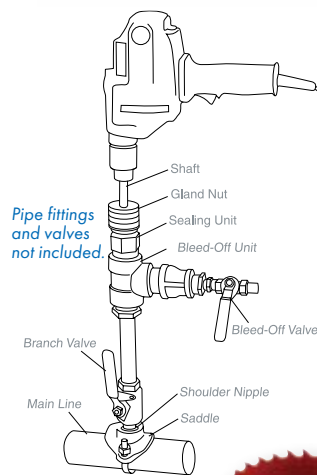

Pipe fittings and valves not included.

**WHY REED?**

A great deal on a versatile tapping machine that is priced well for the market.

**VIDEO TRAINING**

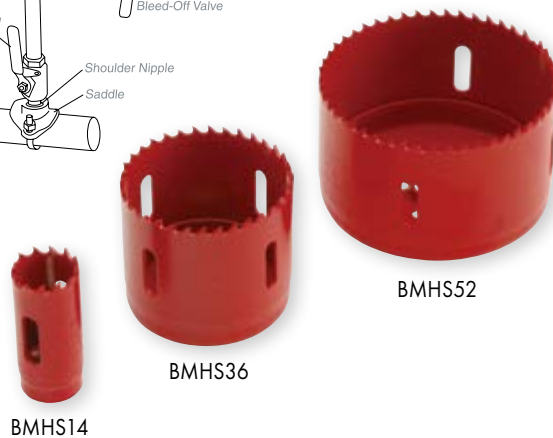

BMHS14

BMHS36

BMHS52

# Tubing Benders

## FEATURES

- Used for bending steel, stainless steel, copper, aluminum and other metal tubing of bending temper.
- TB3456 covers four sizes with one tool.

Catalog No.	Item Code	Tube Capacity*		Bend Radius	Weight	
		Actual O.D. in	mm		lbs	kg
Δ TB3456**	02742	3/16, 1/4, 5/16, 3/8	5, 6.5, 7.9, 9.5	15/16	1.9	0.9
Δ TB04	02745	1/4	-	9/16	1.0	0.5
Δ TB06	02746	3/8	-	15/16	2.0	0.9
Δ TB08	02747	1/2	-	1 1/2	3.5	1.6

\*1/4" = 1/8" nominal, 3/8" = 1/4" nominal, 1/2" = 3/8" nominal

\*\* For annealed tubing

**METRIC SIZES**



TB06

TB3456



PIPE TOOLS & VISES  
SINCE 1896

## Stud Punch

### FEATURES

- Gives fast punches for running wires or lines through metal studs without pre-drilling.
- Punches 20 gauge steel and thinner steel.
- Aluminum head makes for lightweight tool.
- Handle design allows maximum leverage.

Catalog No.	Item Code	Punch Size		Length		Weight	
		in	mm	in	mm	lbs	kg
△ STP710	06465	1 11/32	34.1	21	533.4	6.6	3.0

### PLASTIC GROMMETS

Catalog No.	Item Code	Punch Size		Length		Weight	
		in	mm	in	mm	lbs	kg
△ GR1.3	06475	1 11/32	34.1	1.8	44	0.9	0.4

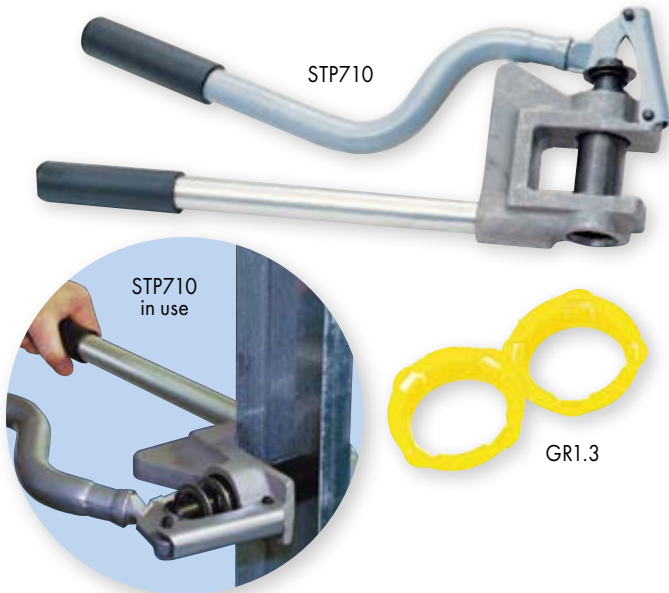

## Multi-Purpose Pipe Joiner

### FEATURES

- Join gasketed pipe up to 14" nominal diameter.
- Works for PVC, ductile iron, clay tile, cast iron soil pipe and concrete pipe.

Catalog No.	Item Code	Capacity		Weight	
		in-nom.	actual O.D. mm	lbs	kg
PJ414	08080	4 - 14	102 - 355	34.0	15.5

NOTE: Not for use with solvent cement joining of plastic pipe.  
Double wrap chain around PVC for best grip.

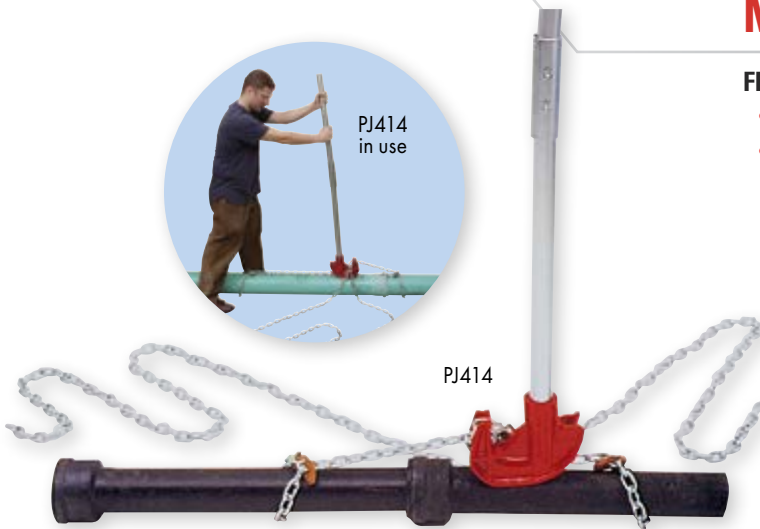

## Torpedo Levels

### FEATURES

- Levels with pitch, level and plumb measurements.
- Magnetic base to sit flat and secure during leveling work.
- Choose model based on intended use.

Catalog No.	Item Code	Material	Size	Description	Weight	
					lbs	kg
LV9PLB	06213	Aluminum	0.7" x 1.3" x 9"	Plumbing Use	0.5	0.2
LV6WW	06214	Aluminum	0.7" x 1.25" x 6.5"	Waterworks Use	0.3	0.1





## Hack Saw & Blades

### FEATURES

- Bi-metal blades provide best performance on steel pipe.
- Tensioning knob for adjustments and quick blade changes.
- Four permanent mounting pins permit both straight cutting and 45° angle for flush cutting.
- Room to store spare blades in frame.

Catalog No.	Item Code	Description	Blade	Throat Depth	Weight	
					lbs	kg
△ HK1228	04489	High Tension Hack Saw	Bi-Metal Blade	3 3/4	1.2	0.5

### BI-METAL BLADES

Catalog No.	Item Code	Length/Width/Thickness		Teeth per Inch	Standard Pack	Weight	
		in-nom.	mm			lbs	kg
△ BH18	04491	12 x 1/2 x 0.025	300 x 13 x 0.6	18	10	0.5	0.2
△ BH24	04492	12 x 1/2 x 0.025	300 x 13 x 0.6	24	10	0.5	0.2
△ BH32	04493	12 x 1/2 x 0.025	300 x 13 x 0.6	32	10	0.5	0.2

NOTE: Coarse teeth (less teeth per inch) are to be used for softer materials like aluminum, brass or low carbon steels. The larger spaces between teeth keep them from clogging with metal fragments. Finer teeth are to be used on tougher or slightly harder materials like alloy, tool steels and some stainless steels.

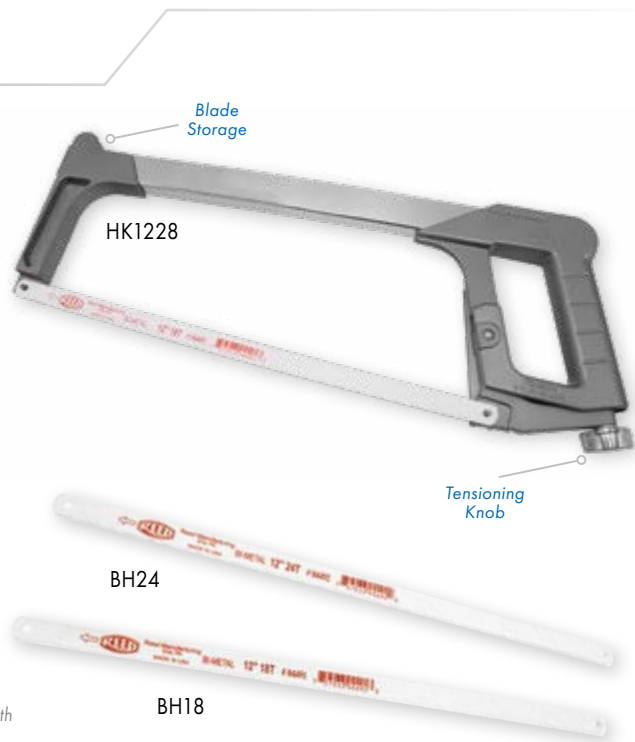

## Water Pump Pliers

### FEATURES

- Designed for one-hand operation.
- Built-in stop prevents hand injuries.
- Angle nose, slip-joint plier style with parallel handles.
- With parallel handles.
- Zinc plating inhibits corrosion.

Catalog No.	Item Code	Pipe Capacity		Length		Weight	
		in-nom.	actual O.D. mm	in	mm	lbs	kg
△ WPP10	02650	2" pipe, 1 1/2" slip nuts	63	10	255	0.9	0.4



## Positive Grip Pliers

### FEATURES

- Offset head design reaches into tight areas and allows for better leverage.
- Top and bottom jaw "v" shape permits pliers to grip a wide variety of shapes.
- Superior fastener surpasses traditional nut and bolt tightness issues.
- Pliers offer seven groove positions.

Catalog No.	Item Code	Pipe Capacity		Length		Weight	
		in-nom.	actual O.D. mm	in	mm	lbs	kg
△ PGP10	02655	1	35	9.5	245	0.7	0.3
△ PGP12	02656	2	63	12	300	1.5	0.7





PIPE TOOLS & VISES  
SINCE 1896



TRC2D

TRC1S

TRC1S  
in use

TRCD3/8

## Threaded Rod Cutters

### FEATURES

- Mounting holes/slots in lower handle provide a permanent mounting option.
- Heat-treated dies for durability.
- Fit the most common threaded rods found in the United States which are 1/4" - 20 UNC, 5/16" - 18 UNC, 3/8" - 16 UNC, 1/2" - 13 UNC.
- Comfort grip on upper handle.

Catalog No.	Item Code	Description	Weight	
			lbs	kg
△ TRC1S	04760	Ships with 3/8" dies; purchase other dies to cut 5/16" or 1/4" threaded rod also	9	4.1
△ TRC2D	04761	Ships with dies for 1/2" and 3/8" threaded rod	16	7.3

Catalog No.	Item Code	Description	Weight	
			lbs	kg
TRCD1/4	04765	1/4" die set	0.2	0.1
TRCD3/8	04767	3/8" die set	0.2	0.1
TRCD1/2	04768	1/2" die set (fits TRC2D only)	0.3	0.1



# YOUR DIRECT LINE TO REED

www.reedmfgco.com

REED PIPE TOOLS & VISES SINCE 1896

PRODUCTS WHERE TO BUY RESOURCES ABOUT REED SEARCH ENGLISH

**CHECK OUT OUR DIGITAL CATALOG**

reedmfgco.com/reed-catalog

**SIGN UP FOR OUR E-MAIL NEWSLETTER**

reedmfgco.com/newsletter-sign-up

**WATCH REED TOOL VIDEOS**

videos.reedmfgco.com

**CONNECT WITH US!**

@ReedPipeTools

@reedpipetools

@ReedManufacturing

@reedpipetools

@reedpipetools

Reed Manufacturing



PIPE TOOLS & VISES  
SINCE 1896

# DISTRIBUTION

REED sells to the professional trades only through traditional distributors as good distributors add value in these important ways:

- ✔ Local stock can save the day and REED's extensive distributor network supplies tools where and when contractors need them.
- ✔ Distributors provide problem-solving efforts such as product recommendations, order expediting and replacement part identification.
- ✔ Distributors also can arrange site visits by REED representatives for tool demonstrations and jobsite solutions.
- ✔ Even REED online retailers have brick & mortar stores and are authorized REED distributors. All REED products are marketed through traditional distributors.

A REED tool sale isn't successfully concluded unless the transaction is smooth and the customer is completely satisfied. Contact us to find distributors in your area.



## REQUEST A TOOL DEMONSTRATION OR CONSULTATION

Email: [reedsales@reedmfgco.com](mailto:reedsales@reedmfgco.com)

Phone: 800.666.3691 or +1 814.452.3691

Online: click on SALES CONTACTS at [www.reedmfgco.com](http://www.reedmfgco.com)





PIPE TOOLS & VISES  
SINCE 1896



Reed Manufacturing Company Headquarters  
Erie, Pennsylvania USA

# ***TRADITIONAL VALUES, CUTTING EDGE SOLUTIONS***

1425 West 8th Street Erie, Pennsylvania 16502 USA  
[reedsales@reedmfgco.com](mailto:reedsales@reedmfgco.com) • Phone: 800.666.3691 or +1 814.452.3691